

pepper

Datasheet 1.8a

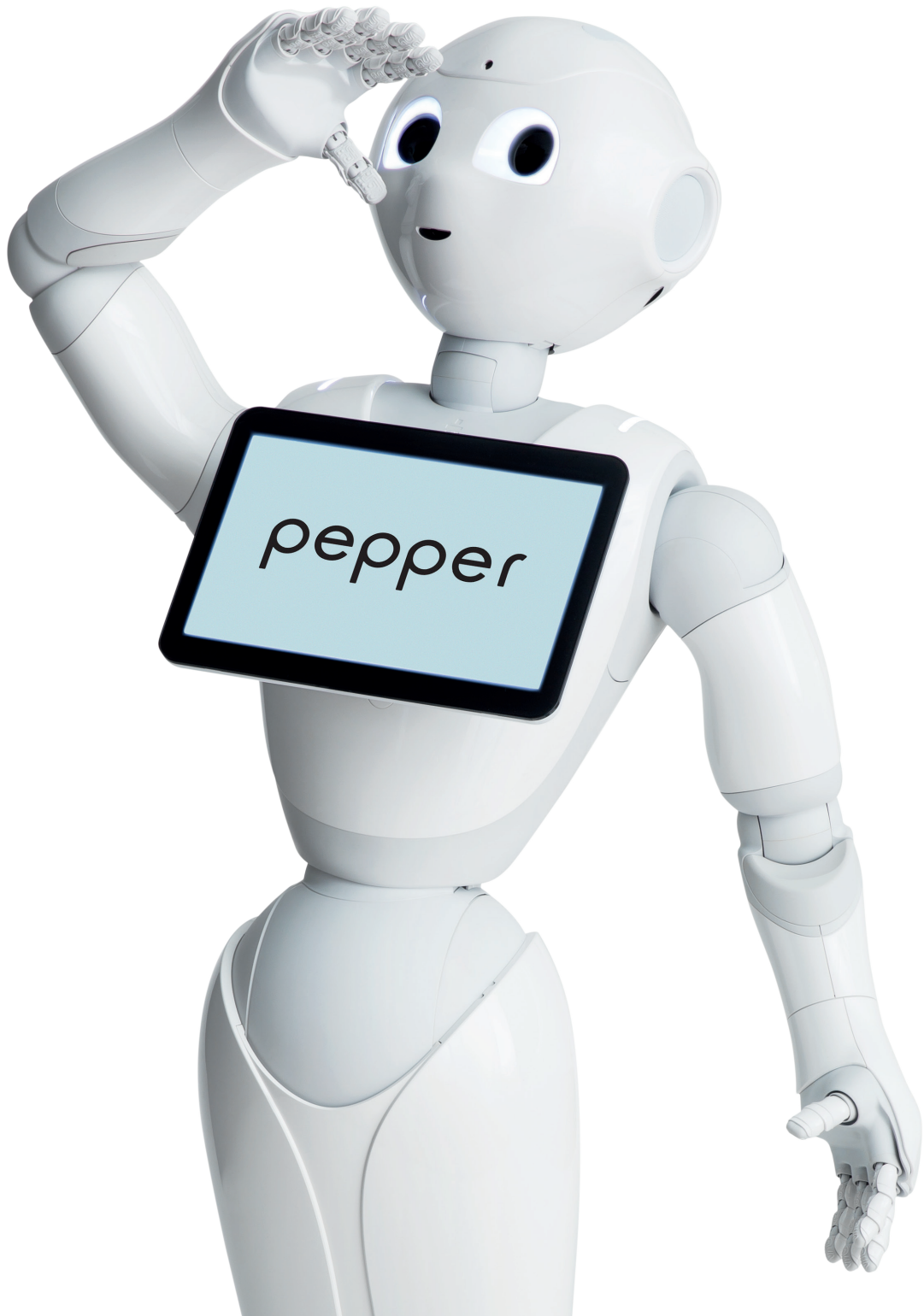

pepper

version 1.8a

P.2

PHYSICAL CHARACTERISTICS

CONSTRUCTION

Dimension (HxWxL)	1208.5 x 477.2 x 424 mm	
Packaging (HxWxL)	1400 x 580 x 580 mm	
Weight	29.10 kg	
Weight with packaging	41.9 kg	
Working temperature range	5°C to 35°C (41°F to 95°F)	
Working humidity range	20% < 80% uncondensed	
Storage temperature range	-10°C to 60°C (14°F to 140°F)	
Storage humidity range	10% < 90%, uncondensed	
IP protection class	IPX0	
Autonomy	Self-discharge	4 months
	Standby mode	19 hours
	Intensive use	12 hours

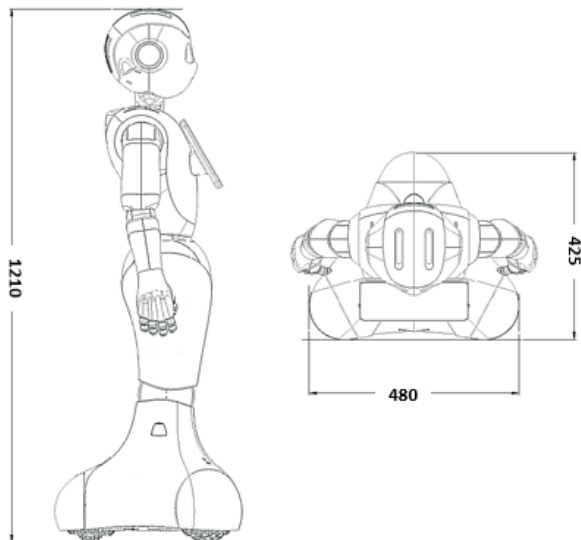

CONSTRUCTION

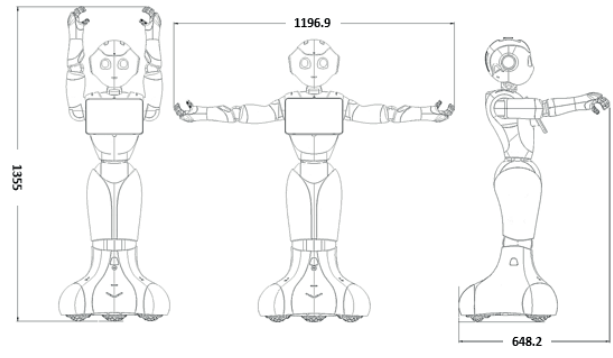

BRAIN SYSTEM

MOTHERBOARD

Processor	ATOM E3845
CPU	Quad core
Clock speed	1.91 GHz
RAM	4 GB DDR3
Flash memory	32 GB eMMC (of which 24 GB available for users)
GPU	Intel HD graphics up to 792 MHz

HUMAN INTERACTION

TABLET

Model	LG CNS Tablet	
Dimensions	246 x 175 x 14.5 mm	
Buttons	Home, Back, Recent	
USB	USB 2.0 OTG Wire to board wafer type (Wi-Fi I/F)	
In-Speaker	20 Hz ~ 20,000 Hz 0.5 W (Normal) / 0.8 W (MAX)	
Microphone	Omnidirectional	
Camera	2 megapixel	
Display (LCD)	Size	10.1"
	Resolution	1280 * 800
	Panel type	TFT
	Touch type	Capacitive

TABLET

SD Socket	Micro SD	
Battery	None	
CPU	CPU: 1.3 GHz quad-core ARM Cortex-A7 MT8127/ Cache 512 KB L2 1.6G pixel/sec@416MHz	
DDR3 SD RAM	1 GB (512 MB * 2)	
Flash memory	32 GB (eMMC)	
Wi-Fi	802.11 a/b/g/n	
Bluetooth version	4.0 (LE)	
Media	File format	AVI, WMV, ASF, MP4, MKV, MPG, DAT, TS, TP, TRP, 3GP
	Video codec	DivX, XviD, H.264, W MV 9/8/7, MPEG1
	Audio codec	MPEG1 Layer 1/2/3, WMA, OGG Vorbis, PCM, FLAC
	Video resolution	Max 1920 * 1080
HTML5 video	File format	MP4
	Video codec	H.264
	Audio codec	AAC
	Video resolution	Max 1280 * 720

Note: Practical video output is limited by network connection. Frame rate depends on CPU usage. Values are calculated with the CPU fully dedicated to image gathering.

AUDIO

Loudspeakers	Location	1 in each ear
	Nominal diameter	25 mm
	Impedance	8 Ω
	Sensitivity	78 dB 1w/1m @ 1kHz
	Frequency response [-10 dB]	70 Hz / 7.2 kHz
	Output power (nominal)	5 W
	Input power (peak)	20 W

AUDIO

Microphones	Location	4 on the head
	Sensitivity	300 mV/Pa +/- 3dB at 1 kHz
	Frequency range	100 Hz - 10 kHz [-10 dB relative to 1 kHz]

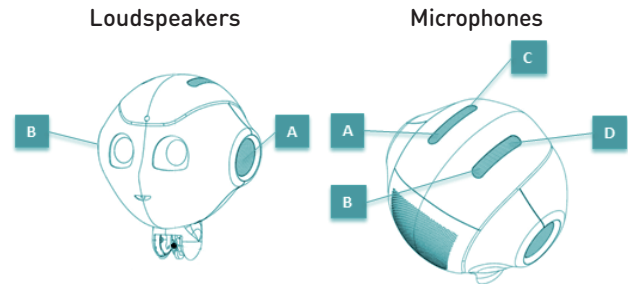

2D CAMERAS

Location	1 in the mouth and 1 in the forehead	
Model	OV5640	
Type	SOC Image Sensor	
Imaging array	Resolution	5 Mp
	Optical format	¼ inch
	Active Pixel (HxV)	2592 x 1944
Sensitivity	Pixel size	1.4 μm * 1.4 μm
	Dynamic range	68 db @8x gain
	Signal/Noise ratio	6 dB (maximum)
	Responsibility	600 mV/Lux-sec
Output	Camera output	640 * 480 @ 30 fps
	Data Format	YUV422 color space
	Shutter type	Rolling shutter / frame exposure
View	Field of view	68.2° DFOV [57.2° HFOV, 44.3° VFOV]
	Focus range	30 cm ~ infinity
	Focus type	Fixed focus

2D CAMERAS

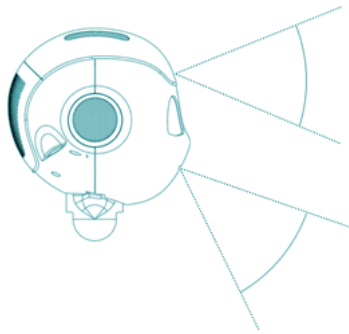

3D CAMERA

Location	In the eyes	
Model	ASUS XTION	
Type	SOC Image Sensor	
Imaging array	Optical format	1/4 inch
	Active Pixels (HxV)	320 x 240
Output	Camera Output	320 * 240 @ 20 fps
	Data Format	{YUV422 color space}
Shutter type	Electronic Rolling shutter (ERS)	
View	Field of view	70.0° DFOV (58.0° HFOV, 45.0° VFOV)
	Focus range	40 cm ~ 8 m

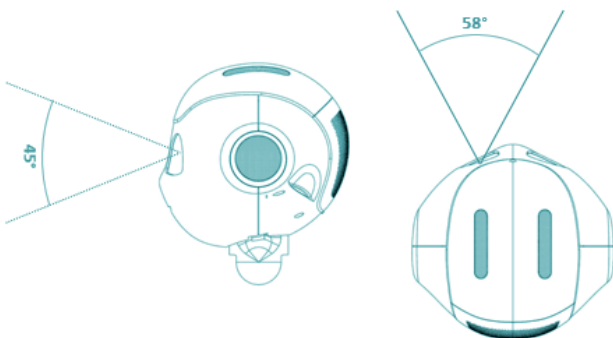

BUTTONS

Chest button	Number	1
	Location	On the chest under the tablet

BUTTONS

Stop button	Number	1
	Location	On the nape of the neck
Wheel bumper	Number	3
	Location	2 in the front and 1 at the back on the Base

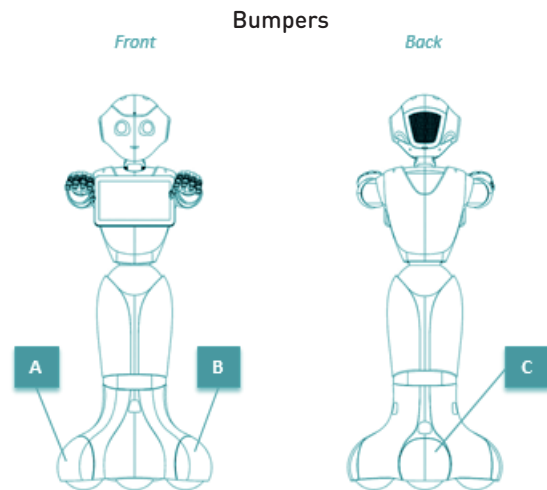
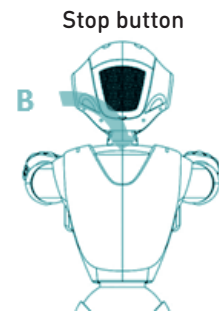

TOUCH SENSITIVITY

Head	Number	3
	Location	On the top of the head
Hand	Number	2
	Location	On the back of both hands

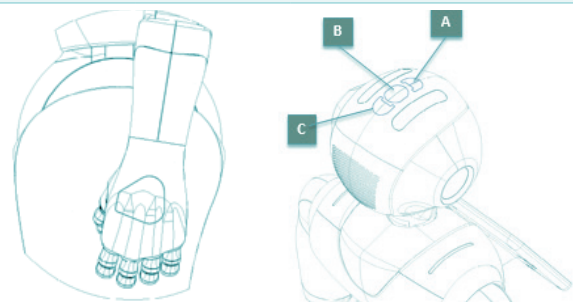

LEDS

Eye LEDs	Quantity	2 x 8
	Color	RGB FullColor
Ear LEDs	Quantity	2 x 10
	Color	16 shades of blue
Shoulder LEDs	Quantity	2 x 2
	Color	RGB FullColor

ENVIRONMENT SENSORS

LASERS

Location	1 on each side of the base (3) 3 in the front of the base 1 in the head
Class	1M
Wavelength	808 nm
Mode of operation	Pulsed
Framerate	6.25 Hz per laser
Global shutter camera	Auto-exposure control
Emission	15 dots projected at 60°E
Detection range	20 cm to 2.8 m at 3 cm above the ground range

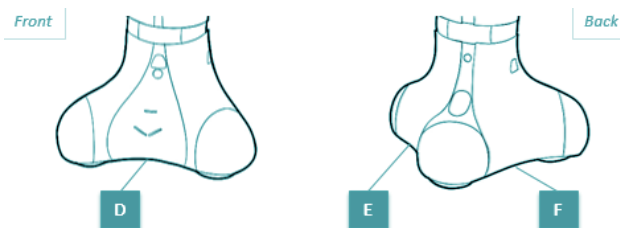
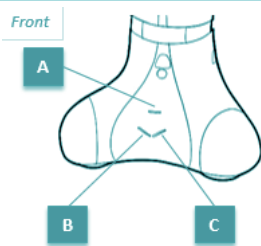

IR SENSORS

Location	1 on both sides (2)
Wavelength	808 nm
Range	0 to 50 cm at 27 cm above the ground
Angle	2°

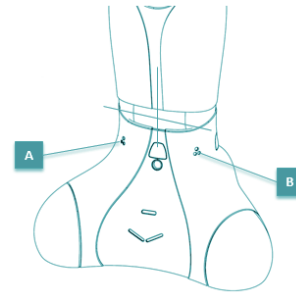

SONARS

Location	1 in front and 1 at the back on the base
Frequency	42 kHz
Sensitivity	-86 dB
Resolution	0.03 m
Detection range	0* - 5m depending on object type * Closer than 0.3m will range as 0,3m
Effective cone	60° depending on the object type

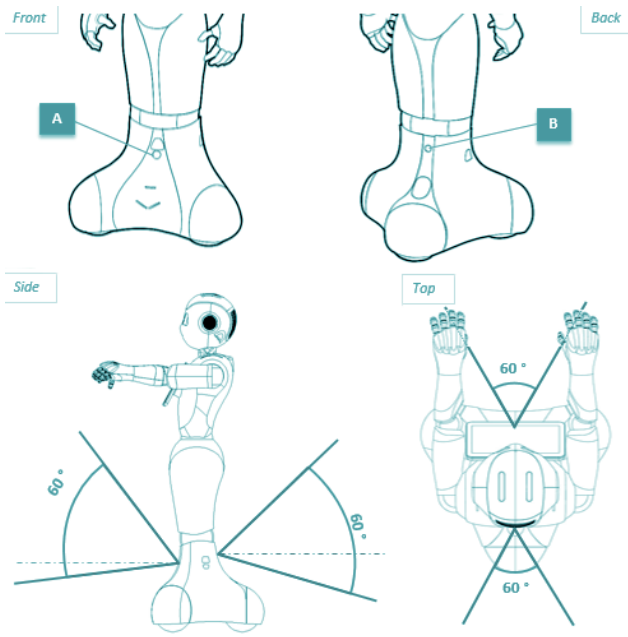

INERTIAL UNIT

Number	1
Composition	3-axis gyrometer with an angular speed of ~500°/s 3-axis accelerometer with an acceleration of ~2 g

MOTION

MOTORS

Location	Degrees of freedom	Movement
Head	2	HeadYaw
		HeadPitch
Arms	4	ShoulderPitch
		ShoulderRoll
		ElbowYaw
		ElbowRoll
Hands	2	WristYaw
		Hand
Leg	3	HipRoll
		HipPitch
		KneePitch
Base	3	WheelFL
		WheelFR
		WheelB

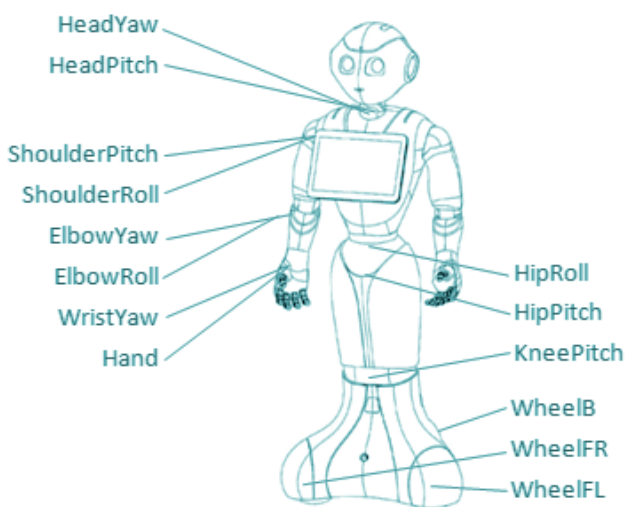

ROTATION SENSORS

MRE (Magnetic Rotary Encoder)	Number	30
	Sensor type	Hall effect sensor
	Precision	0.1°

MOTORS POWER

Motion speed	Up to 2 km/h
Climbing	Up to 1,5 cm
Max. slope	5°

CONNECTIVITY

TECHNOLOGIES

Wi-Fi	802.11 a/b/g/n 64/128 bit: WEP, WPA/WPA2
Ethernet	1xRJ45 10/100/1000 base T
Bluetooth®	4.0

ENERGY

BATTERY

Type	Lithium-Ion	
Voltage	Nominal voltage	26.46 V
	Battery robot protection	22.5 V-24.2 V (depending on temperature)
	Battery under voltage protection	17.5 V
	Battery voltage lockout	11.9 V
	Max. charge	29.4 V

BATTERY

Current	Max. charge	8 A
	Use in active mode	Max. 3.5 mA (battery electronic)
	Use in stand-by mode	Max. 850 μ A (battery electronic)
	Use in power down mode (V < 2.5 V per cell)	Max. 50 μ A (battery electronic)
Typ. capacity	30 Ah 795 Ah	
Charging method	Constant Current / Constant Voltage	
Cycle life	Min.	300 \geq 20.65 Ah (70% of the capacity at 25°C)
	Expected	1000 \geq 70% of the capacity at 25°C
Operating temperature	Charging	0 to + 50°C
	Discharging	0 to +50°C
	Thermal protection	The battery interrupts charge/discharge when the temperature limits are reached.
Esd (en 61000-4-2 / 12.2009)	Air discharge	8 kV
	Contact discharge	4 kV
Weight	4.72 kg	

BATTERY CHARGER

Working temperature range	-5°C to 40°C (23°F to 104°F)	
Working humidity range	10% < 80% uncondensed	
Storage temperature range	-20°C to 70°C (-4°F to 158°F)	
Storage humidity range	5% < 95% uncondensed	
Charger life	3 years or 1000 cycles and 30 K hour minimum	

BATTERY CHARGER

Input Voltage range	100 ~ 240 V AC	
Charger input frequency if AC	47/63 Hz	
Output voltage	29.2 V DC	
Output max current	8 A	
Charging duration when robot is OFF	2 h	50% of charge
	3 h 30 min	80% of charge
	8 h	100% of charge
Full charge indication	LED pass to solid green at 99.4% in 6 h 30 min	
Casing dimension (HxWxD)	45 x 204 x 104 mm	
Weight	1.36 kg	
Weight (with packaging)	1.66 kg	
Packaging (HxWxD)	60 x 355 x 270 mm	
Cable length	AC	1.85 m
	DC	1.75 m
Casing material	Plastic	
Connector material	AD	PVC, PP, Brass, PA66
	DC	ABS-PC Ti02, Silicone 60 shore A, Paint UV coating

MATERIALS

LIST OF MATERIALS

Body (white parts) and Chest Button	ABS-PC + Paint/UV coating
Body (grey parts)	PA + GF resin
Soft parts	ABS-PC + TPV +Paint/UV coating, TPV + Paint/UV coating

LIST OF MATERIALS

Base	ABS-PC, ABS-PC + Paint/UV coating
Base camera lens	PC
Wheels	PA + GF resin, PA + GF resin + TPU
Speaker / Microphone mesh	Steel + paint
LED lamp (shoulder)	PMMA
Eyes	PC + Ir ink, PC + Paint/UV coating
Ears	PC + Paint/UV coating
Mouth	ABS
Fingers	ABS-PC + Paint/UV coating, Silicone, PA + GF resin
Waist rubber	TPSiV
Charging port	ABS-PC
Charging terminal	Brass
Metal Pin	Steel alloy + Silicone
Plastic Pin	ABS-PC