

# avocor<sup>TM</sup>

## AVF-7510 Super-slim UHD LED Display\*



Model AVF-7510 Installation/Operation Manual

\*Formally known as VTF-7510

## **COPYRIGHT AND TRADEMARKS:**

© Copyright 2016. This document contains proprietary information protected by copyright, trademark and other intellectual property laws. All rights are reserved. No part of this manual may be reproduced by any mechanical, electronic or other means, in any form, without our prior written permission.

The trademarks reproduced in this document and used on the products are either owned or licensed by us, or by their respective holders. You may not reproduce or use the trademarks without our prior written consent.

# Important Safety Instructions

- Before using this display, please read this user manual thoroughly to help protect against property damage and to ensure your personal safety and the safety of others.
- Be sure to observe the following instructions.
- For your safety, be sure to observe the warnings located in this manual.
- For installation or adjustment, please follow the instructions in this manual and refer all servicing to qualified service personnel.

## Safety Precautions

- If smoke or a peculiar smell comes from the display, remove the power plug from the outlet immediately.
- Failure to do so may result in fire or electrical shock. Contact your dealer for inspection.
- If the display has been turned on but there isn't a picture, remove the power plug from the outlet immediately.
- Failure to do so may result in fire or electrical shock. Contact your dealer for inspection.
- If water is spilled or objects are dropped inside the display, remove the power plug from the outlet immediately.
- Failure to do so may result in fire or electrical shock. Contact your dealer for inspection.
- If the display is dropped or the cabinet is damaged, remove the power plug from the outlet immediately.
- Failure to do so may result in fire or electrical shock. Contact your dealer for inspection.
- To turn off the power of the display, press "O" on the main power switch at side of display.
- The power standby/on indicator will go off and the display cannot to be turned on/off by using the POWER button on the remote control. (To turn on/off the display by the remote control, press the main power switch again and light the power standby/on indicator.)
  - ◆ When turning off the display by pressing the POWER button on the remote control, the main power of the display is not turned off completely.
  - ◆ To disconnect power completely, remove the power plug from the outlet.
- If the power cord or plug is damaged or becomes hot, turn off the main power switch of the display, make sure the power plug has cooled down and remove the power plug from the outlet.
- If the display is still used in this condition, it may cause fire or electrical shock. Contact your dealer for replacement.

## Installation

- Don't install in a high-temperature environment.
- If the display is used in high-temperature or in direct sunlight, it may cause the case or other parts to become distorted or damaged, resulting in overheating or electrical shock.
- Don't install in a high-humidity environment.
- This may cause overheating or electrical shock.
- Don't install near any heat sources such as radiators, heat registers, stoves, or other apparatus that produce heat.
- This may cause fire or electrical shock.
- Don't overload outlets or cables beyond electrical capacity.
- Don't use extension cords as it may cause fire or electrical shock.
- Don't insert the power plug into an outlet other than 100~240V AC.
- This may cause fire or electrical shock.
  - ◆ Don't use a damaged power plug or worn outlet.
  - ◆ Don't insert an improper power plug it may cause fire or electric shock.
- Don't place the display on an unstable shelf or surface.
- The display may fall, causing injury. Please install on a horizontal, stable, level surface.
- Don't place objects on the display.
  - ◆ If the display is covered or the vents are blocked, the display could overheat and cause a fire.
  - ◆ If metal or liquid gets into the display, it may cause fire or electrical shock.
  - ◆ Do not put heavy objects on the display as they may fall, causing injury.
  - ◆ Please keep a 10 cm minimum distance between the display and the wall for sufficient ventilation.
- Don't move the display when it is connected to the power cord and AV cables.
  - ◆ When moving the display, make sure to remove the power plug and cables from the outlet or source.
  - ◆ When unpacking or carrying the display, at least 2 people are needed. Make sure the display is carried upright.
  - ◆ Transport the display upright. Avoid placing the display face up or down.
  - ◆ Handle the display gently. Do not drop.

## Use

- If you encounter a problem during installation, please contact your dealer for assistance. Don't repair or open the display by yourself.
- Failure to do so may result in fire or electrical shock. Contact your dealer for inspection.
- Protect and correctly use the power cord/plug.
  - ◆ Don't pinch the power cord/plug between hard surfaces.
  - ◆ Don't step on the power cord/plug.
  - ◆ Before inserting the power plug into the wall outlet, connect the power cord to the display.
  - ◆ Don't operate the display with a damaged power cord or it may damage the display.
- Using extension cords (not recommended)
- If an extension cord must be used, ensure the voltage rating exceeds the max power consumption of the display. If the voltage rating is less than the display, it will cause the extension cord to overheat.
- If there is thunder or lightning, don't touch the display or the power plug.
- This may cause an electric shock.
- Don't use any kind of liquid on the display.
  - ◆ If liquid is spilled on the display, remove the power and ask qualified service personnel to check the display.
  - ◆ If the liquid gets on the display's screen, please clean it with a dry and soft cloth immediately.
  - ◆ Don't use any harsh chemical on the display.
  - ◆ If metal or liquid gets into the display, it may cause a fire or an electrical shock.
- Don't install or remove the power plug with wet hands.
- This may cause an electrical shock.
- If the display will not be used for a long period of time, unplug the display.
- This may cause premature wear of electrical components or fire.
- Don't press on the LCD panel.
- This may cause personal injury or panel damage.
- Don't push or shake the display.
- This may cause damage or injury.
  - ◆ If the glass of the display panel is broken, liquid may escape. Please don't touch the liquid.
  - ◆ If liquid get into your eyes or touches your skin, wash with the clean water and seek medical attention immediately.
  - ◆ Precautions with the remote control batteries
  - ◆ Please only use approved AAA type batteries.
  - ◆ Please be sure to insert batteries by matching the + and -.
  - ◆ Don't recharge, heat, disassemble, short or throw batteries into a fire.

- ◆ Don't mix a new battery with a used one.
- ◆ Don't mix different types of batteries together (only use the specified type). it may cause burn and injury.

## Cleaning

- If dust has collected on the power plug, removed the plug from the outlet and clean off the dust.
- Dust build-up may cause a fire.
- Take off the power plug before cleaning.
- Failure to do so may result in electrical shock or damage.
- Cleaning the surface of the display
  - ◆ When the surface of the display becomes dirty, please wipe the surface lightly with a soft clean cloth.
  - ◆ If the surface requires additional cleaning, lightly moisten the cloth.
  - ◆ Do not to let any kind of liquid enter the display as it may cause electrical shock or damage.
  - ◆ Do not clean the display with alcohol, solvents or ammonia, as this could damage the display.

# Warnings

## Use

- Do not use the display lying flat on its back.
- Transport the display upright with proper packaging. Avoid placing the display face up or down. Be careful not to bump into the display.
- Do not send a static (non-moving) image to the display, or it may cause image 'burn-in' or image retention.
- "Burn in" and/or image retention is not covered under warranty.
- Make sure to change the image on the display periodically. It is recommended to (1) turn off the display for at least 6 hours after 18 hours of usage in a 24 hour period to help avoid image retention and (2) to turn the "IRFM" function to "ON" in the OSD menu (under "Advanced Settings").

## Exemptions

- This product isn't warranted for any damage caused by natural disaster (such as earthquake, thunder, etc.), fire, acts by third parties, accidents, owner's intentional misuse and fault, or use in other improper conditions.
- This product isn't warranted for incidental damages (such as profit loss or interruption in business, modification or erasure of record data, etc.) caused by use or inability to use of this product.
- This product isn't warranted for any damage caused by inappropriate operation, or from not following the user manual.
- This product isn't warranted for any damage caused by misuse or malfunction through simultaneous use of this product and the connected equipment or software.
- This product isn't warranted for any damage caused by neglect of the instructions described about installation.
- This product isn't warranted for any damage caused by improper installation.
- This product isn't warranted for any damage caused by disassembly, modification or repair by non-authorized service centre or people.

# Compliance Information

## DECLARATION OF CONFORMITY:

AVOCOR hereby declares that the Product's Model Number:

AVF-7510

Conform with the provisions of:

- FCC:  
FCC CFR Title 47 Part 15 Subpart B Class A, CISPR 22  
ANSI C63.4  
ICES-003 Issue 5
- CE:  
1999/5/EC  
EN 55022  
EN 55024  
EN 61000-3-2  
EN 61000-3-3
- cTUVus:  
UL 60950-1  
CAN/CSA-C22.2 No. 60950-1-07
- CB:  
IEC 60950-1

## FCC PART 15:

This equipment has been tested and found to comply with the limits for a Class A digital device, pursuant to part 15 of the FCC Rules. These limits are designed to provide reasonable protection against harmful interference when the equipment is operated in a commercial environment. This equipment generates, uses, and can radiate radio frequency energy and, if not installed and used in accordance with the instruction manual, may cause harmful interference to radio communications. Operation of this equipment in a residential area is likely to cause harmful interference in which case the user will be required to correct the interference at his own expense.

### CAUTION:

Any changes or modifications not expressly approved by the grantee of this device could void the user's authority to operate the equipment.

### RF Exposure Warning:

This equipment must be installed and operated in accordance with provided instructions and the antenna(s) used for this transmitter must be installed to provide a separation distance of at least 20 cm from all persons and must not be co-located or operating in conjunction with any other antenna or transmitter. End-users and installers must be provided with antenna installation instructions and transmitter operating conditions for satisfying RF exposure compliance.



## INDUSTRY CANADA (ICES-003):

CAN ICES-3 (A)/NMB-3(A)

## PRODUCT DISPOSAL:

The Product contains small amounts of tin, lead and/or mercury. Disposal of these materials may be regulated due to environmental considerations.

## DISPOSAL OF OLD ELECTRICAL AND ELECTRONIC EQUIPMENT (Applicable throughout the European Union and other European countries with separate collection programs)



This symbol found on your product or on its packaging, indicates that this product should not be treated as household waste when you wish to dispose of it. Instead, it should be handed over to an applicable collection point for the recycling of electrical and electronic equipment. By ensuring this product is disposed of correctly, you will help prevent potential negative consequences to the environment and human health, which could otherwise be caused by inappropriate disposal of this product.

The recycling of materials will help to conserve natural resources. This symbol is only valid in the European Union. If you wish to discard this product, please contact your local authorities or dealer and ask for the correct method of disposal.

# Notes

# Table of Contents

Important Safety Instructions .....	3
Safety Precautions .....	3
Installation .....	4
Use .....	5
Cleaning .....	6
Warnings .....	7
Use .....	7
Exemptions .....	7
Compliance Information .....	8
Table of Contents .....	11
List of Figures .....	13
<b>1. Introduction .....</b>	<b>15</b>
<b>About This Manual .....</b>	<b>15</b>
Target Audience .....	15
Textual and Graphic Conventions .....	15
<b>Using This Manual .....</b>	<b>16</b>
<b>Description, Features and Benefits .....</b>	<b>17</b>
Key Features and Benefits .....	17
Touch Capability: .....	17
Parts List .....	18
<b>2. Controls and Functions .....</b>	<b>19</b>
<b>Display at a Glance .....</b>	<b>19</b>
<b>Input Panel .....</b>	<b>21</b>
<b>Remote Control Unit .....</b>	<b>23</b>
<b>3. Installation .....</b>	<b>25</b>
<b>Remote Control .....</b>	<b>25</b>
Notes on Batteries .....	25
Notes on Remote Control Operation .....	25
<b>Quick Setup .....</b>	<b>26</b>
<b>Installation Considerations .....</b>	<b>26</b>
Ambient Light .....	26
Ambient Heat .....	26
Ventilation .....	27
<b>Mounting the Display .....</b>	<b>28</b>
<b>Connections to the Display .....</b>	<b>28</b>
Connecting a Control System or PC: .....	29
Connecting Source Components to the Display .....	31
<b>Turning on the Power .....</b>	<b>33</b>
<b>Changing the OSD Language .....</b>	<b>34</b>
<b>Enabling the Touch Screen .....</b>	<b>34</b>
Connecting the Touch Screen Controller Host Computer to the Display .....	34
Software Installation .....	35
<b>4. Operation .....</b>	<b>39</b>
<b>Using the On-Screen Menus .....</b>	<b>39</b>
Input Menu .....	41

Picture Menu.....	42
Audio Menu .....	44
OSD Settings Menu.....	45
Setup Menu.....	46
Advanced Setup Menu.....	47
Communication Menu .....	49
Information.....	50
<b>5. Maintenance and Troubleshooting .....</b>	<b>51</b>
<b>Maintenance.....</b>	<b>51</b>
<b>Troubleshooting .....</b>	<b>51</b>
<b>6. External Control.....</b>	<b>54</b>
<b>Serial Communications .....</b>	<b>54</b>
RS-232 Connection and Port Configuration .....	54
Command and Response Format.....	54
Command and Response Examples.....	55
Serial Command List.....	55
<b>Using Discrete IR Codes.....</b>	<b>64</b>
IR Command Protocol.....	64
IR Control Code List.....	65
<b>7. Specifications.....</b>	<b>67</b>
Supported Timings.....	69
Overall Dimensions .....	71
<b>Appendix I: Moving and Carrying Notice.....</b>	<b>73</b>
Moving the Display:.....	73
Carrying the display:.....	73
<b>Appendix II: Installing a Wall Mount .....</b>	<b>74</b>
<b>Appendix III: Installing an OPS Module .....</b>	<b>75</b>
<b>Appendix IV: Wall Mount Safety Notes.....</b>	<b>76</b>
<b>Appendix V: Power/ PC Key Operations.....</b>	<b>78</b>
<b>Appendix VI: Ethernet Remote Control Settings .....</b>	<b>79</b>
<b>Configurations.....</b>	<b>79</b>
Administrator.....	79
TCP Mode.....	82
UDP Mode .....	83
UART .....	84
SMTP .....	85
Reset Device.....	86

# List of Figures

- Figure 2-1. Display Rear/ Side / Front View ..... 19
- Figure 2-2. Display Input Panel Side/Front View ..... 21
- Figure 2-3. Display Remote Control Unit ..... 23
- Figure 3-1. Ventilation Requirements for Enclosure Mounting..... 27
- Figure 3-2. RS-232 Control System Connection ..... 29
- Figure 3-3. Ethernet Connection ..... 30
- Figure 3-4. DisplayPort Source Connection ..... 31
- Figure 3-5. HDMI Source Connections ..... 32
- Figure 3-6. VGA Source Connections ..... 33
- Figure 3-7. Touch Screen Controller (USB) Connection ..... 34
- Figure 4-1. OSD Menu Structure ..... 40
- Figure 7-1. AVF-7510 Display Dimensions ..... 71

# Notes

# 1. Introduction

## About This Manual

This Owner's Manual describes how to install, set up and operate the AVOCOR Series LED Display.

Throughout this manual, the AVOCOR Series LED Display is referred to as the "display".

## Target Audience

The manufacturer has prepared this manual to help installers and end users get the most out of the display.

The manufacturer has made every effort to ensure that this manual is accurate as of the date it was printed. However, because of ongoing product improvements and customer feedback, it may require updating from time to time.

## Textual and Graphic Conventions

**Text Conventions:** The following conventions are used in this manual, in order to clarify the information and instructions provided:

- Remote and built-in keypad button identifiers are set in upper-case bold type; for example, "Press **EXIT** to return to the previous menu."
- Computer input (commands you type) and output (responses that appear on-screen) is shown in monospace (fixed-width) type; for example: "To change the aspect ratio to Letterbox, type 07 00 02 41 53 50 03 08 <Enter>."
- All keys with functional names are initial-capped, set in bold type and enclosed in angle brackets. These keys are the following: <Enter>, <Spacebar>, <Control>, <Esc> and <Tab>. <Enter> indicates that you may press either the RETURN or ENTER key on your keyboard if it has both keys.
- In addition to these conventions, underlining, bold face and / or italics are occasionally used to highlight important information, as in this example:



**NOTE**

*A carriage return must be used after each command or string.*

**Graphic Conventions:** These symbols appear in numerous places throughout the manual, to emphasise points that you must keep in mind to avoid problems with your equipment or injury:



**TIP**

TIPS highlight time saving short cuts and helpful guidelines for using certain features.



**NOTE**

NOTES emphasise text with unusual importance or special significance. They also provide supplemental information.



**CAUTION**

CAUTIONS alert users that a given action or omitted action can degrade performance or cause a malfunction.



**WARNING**

WARNINGS appear when a given action or omitted action can result in damage to the equipment, or possible non-fatal injury to the user.



**DANGER!**

DANGER appears when a given action can cause severe injury or death.

## Using This Manual

Use the following table to locate the specific information you need in this manual.

If you need...	... Turn to page:
General information about the AVOCOR Series LED Display	<a href="#">17</a>
Installation instructions	<a href="#">25</a>
First-time configuration instructions	<a href="#">34</a>
Advanced configuration instructions	<a href="#">47</a>
Troubleshooting tips	<a href="#">51</a>
Product specifications	<a href="#">67</a>



## Description, Features and Benefits

The **AVF-7510** is a ultra-high definition touch display that supports a full 3840x2160 @ 60 Hz resolution and can display 1.073 billion colours.

They combine ultra-high resolution and unparalleled image quality with configurable I/O in a large-format display for a wide range of digital signage and control-room applications.

### Key Features and Benefits

The display offers these key features and benefits:

- Up to 3840x2160 @ 60 Hz resolution
- High-resolution, high-speed InGlass™ touch sensing for up to 10 simultaneous touches
- Can display up to 4 video sources simultaneously
- (4) HDMI v1.4 inputs and DisplayPort 1.2 input with High-bandwidth Digital Content Protection (HDCP), VGA, RS-232, USB 2.0/3.0, Touch USB and LAN connections
- An optional OPS (Open Pluggable Specification) slot
- Full-range internal speakers
- Signal source auto detection
- Flexible ON/OFF scheduler
- Low power consumption

### Touch Capability

- Precise, highly responsive touch technology
- High touch sensitivity – no pressure required
- Any touch: finger, gloved hand or pointer
- Calibrated easily by software tools as attached
- Windows 7/8/10 compliant
- One USB cable for easy Plug-and-Play operation

## Parts List

Your display is shipped with the following items. If any items are missing or damaged, please contact your dealer or Customer Service.

- AVOCOR UHD LED Display
- Remote Control Unit and Batteries
- AC Power Cord
- Touch Stylus
- RF Antenna
- USB Key – Multi-Touch Drivers & User Manual
- USB Cable - 3 Metres
- HDMI Cable - 3 Metres
- VGA Cable - 3 Metres

## 2. Controls and Functions

### Display at a Glance

Figure 2-1 shows the key display components, and the paragraphs that follow describe them.

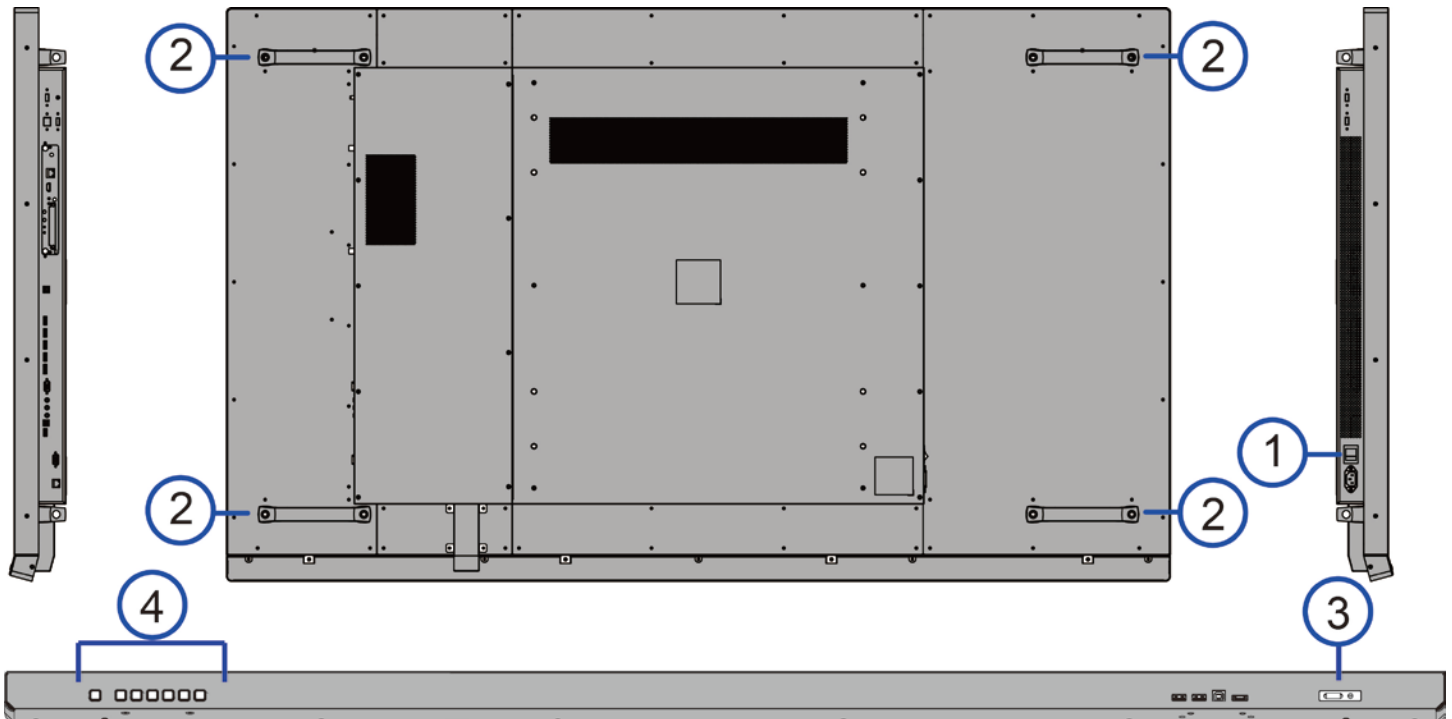

**Figure 2-1. Display Rear/ Side / Front View**

**1. MAIN POWER SWITCH**

Connects or disconnects the display panel from the AC power source.

**2. HANDLE**

Always use the handles and lower handlebars (AVF-6510) when carrying the display.  
DO NOT touch / hold the screen face or the lower front panel.

**3. STATUS LED**

Solid orange: display in standby mode

Blinking orange: display on, no input detected

Off: main power switch off

Solid green: display on, input detected

#### 4. KEYPAD

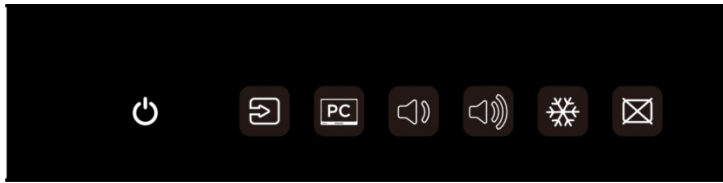

You can use the keypad instead of the remote control unit to operate the on-screen display (OSD) controls. The keypad operates as follows:

POWER 

Press the button to turn off/on the monitor screen. (Refer to Appendix V for detailed operations.)

SOURCE 

Press the button to select a media source. When using WIN PC, pressing this button will return to the previous source selected.

Win10 PC 

Press the button to turn on/off the Win10 PC that's built in the display. (Refer to Appendix V for detailed operations.)

VOLUME DOWN  / UP 

Press these two buttons to lower or increase the volume.

FREEZE 

Press the button to freeze the screen. Press again to release it.

BLANK 

Press the button to blank the screen.

# Input Panel

Figure 2-2 shows the display input panel.

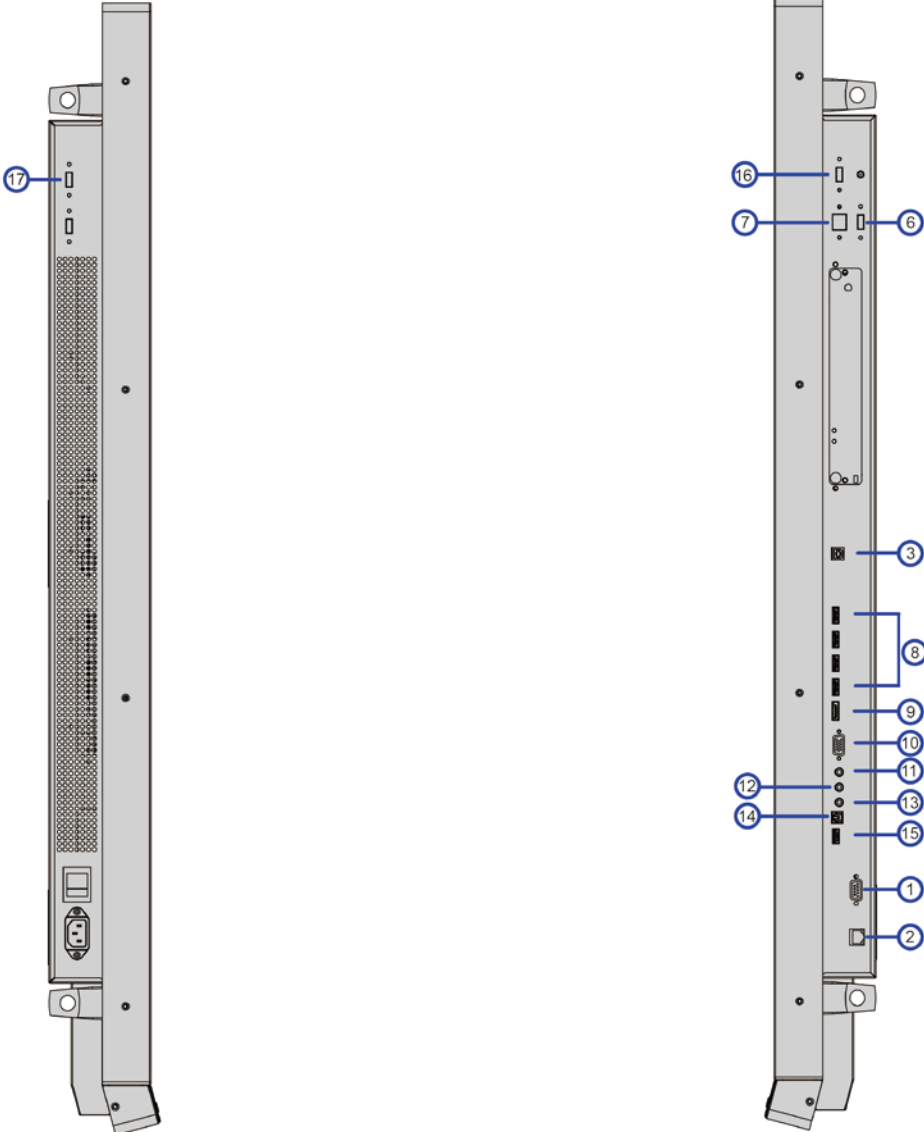

Figure 2-2. Display Input Panel Side/Front View

No.	Connector
1	<b>RS232C In</b> A female, 9-pin D-sub connector for interfacing with a PC or home theatre automation/control system.
2	<b>LAN Port</b> An RJ-45 connector for interfacing with a PC or home theater automation/control system via a Cat 5 cable.
3, 19	<b>Hub In (Touch USB)</b> Two standard, Type-B USB port for connecting media sources to the display.  <b>Note:</b> The USB cable used for the front Hub In connector can be up to 3 metres in length, while the one used for the rear Hub In connector can be up to 5 metres in length.
4	<b>RF Antenna</b> Established a network connection for the display to go online via WIFI.
5	<b>OPS (Open Pluggable Specification) Slot</b> An optional OPS slot for connecting an internal PC to display 4K content.
6, 20	<b>WIN PC USB</b> Two standard USB connectors of the Windows mini PC for connecting external multimedia player devices.
7	<b>WIN PC Ethernet</b> An RJ-45 connector for interfacing with the built-in Windows PC via a Cat 5 cable.
8, 18	<b>HDMI</b> HDCP-compliant digital video input for connecting HDMI sources.
9	<b>DisplayPort</b> DisplayPort 1.1a and DisplayPort-HDCP 1.1 compliant, SD/HD input for connecting SDTV, EDTV or HDTV component video sources.
10	<b>VGA In (15-pin D-Sub)</b> Connects components that have RGB or component output jacks, such as a personal computer or external DTV decoder (a break-out cable is needed for BNC-type connection).
11	<b>PC Audio In</b> Connects the audio output from a personal computer here.
12	<b>IR Extender</b> Connects an IR Extender cable from this input.
13	<b>Audio Out</b> Connects external, powered speakers or an external audio receiver/amplifier.
14	<b>SPDIF Out</b> Connects external and powered digital speakers or audio receiver/amplifier.
15	<b>Service Port</b> A standard USB connector for connecting the USB stick that comes with the package to upgrade firmware.
16	<b>OPS USB</b> A standard USB connector of the OPS slot for connecting external multimedia player devices.
17, 21	<b>HUB USB</b> Two standard USB connectors for connecting external media, keyboard, keyboard or mouse.









# Remote Control Unit

Figure 2-3 shows the display remote control, and Table 2-1 describes its functionality.



Figure 2-3. Display Remote Control Unit

Table 2-1. Remote Control Button Descriptions

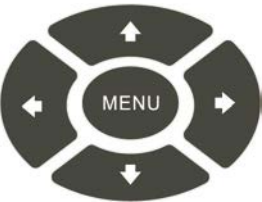
Label	Description
	Turns the monitor on and off. (Refer to Appendix V for detailed operations.)
	Selects a media source.
	Turns on WIN PC, and selects WIN PC input source. (Refer to Appendix V for detailed operations.)
	Blanks the screen. Press any key to restore.
	Freezes the screen. Press again to restore.
	Turns off the sound.
	Increases or decreases the volume by pressing the + and - keys.
	Selects standard settings.
	Opens the monitor's on-screen menu system.
	When the menu system is already open, pressing this button will select the previous submenu.
	Navigates through submenus and settings.
ENTER	Selects highlighted menu choices
EXIT	Closes the menu system
AUTO	Auto adjustment of VGA source
SCALING	Selects each aspect ratio, in sequence: Full Screen, Native, Letter Box and Pillar Box



# 3. Installation

**NOTE**

*Installation must be performed by a qualified custom video installation specialist.*

## Remote Control

To install batteries in the remote control:

1. Press down the tab on the cover and pull the cover up.
2. Insert the included batteries. Ensure that the polarities correctly match the  $\oplus$  and  $\ominus$  markings inside the battery component.
3. Insert the lower tab of the cover into the opening, and press down the cover until it clicks in place.

### Notes on Batteries

Make sure that the battery polarities are correct when installing the batteries.

- Do not mix an old battery with a new one or different types of batteries.
- If you will not use the remote control for a long time, remove the batteries to avoid damage from battery leakage.
- Do not expose batteries to excessive heat such as from sunshine, fire or the like.

### Notes on Remote Control Operation

Make sure that there is nothing obstructing the infrared beam between the remote control and the IR receiver on the display.

- If the effective range of the remote control decreases, or it stops working, replace the batteries with new ones.
- The remote control may fail to operate if the infrared remote sensor is exposed to bright sunlight or fluorescent lighting.
- Ambient conditions may possibly impede the operation of the remote control. If this happens, point the remote control at the display, and repeat the operation.

## Quick Setup

Table 3-1 gives a quick overview of the display installation process. The sections following this one provide detailed instructions.

**Table 3-1. Installation Overview**

Step	Procedure	For Details, Refer to page...
1	Mount the display(s) on a wall (optional)	<a href="#">28</a>
2	Connect other external equipment to the display (optional): Automation/control system (RS-232, Ethernet)	<a href="#">28</a>
3	Connect signal sources to the display	<a href="#">31</a>
4	Apply power to the display	<a href="#">33</a>
5	Change the OSD language (optional)	<a href="#">34</a>
6	Perform touch screen-specific installation and configuration tasks (AVOCOR): Connect touch screen controller host computer to the display	<a href="#">35</a>
7	Display calibration - adjust the following for each input: <ul style="list-style-type: none"><li>• Aspect ratio</li><li>• Brightness</li><li>• Contrast</li><li>• Colour temperature and white balance</li><li>• Color level</li><li>• Tint</li><li>• Input position</li></ul>	<a href="#">41</a>

## Installation Considerations

Proper installation of your display will ensure a satisfying viewing experience. Whether a display is installed temporarily or permanently, the following should be taken into account to ensure the best performance of the display.

### Ambient Light

In general, minimise or eliminate light sources directed at the screen. Contrast ratio in your images will be noticeably reduced if light directly strikes the screen, such as when a shaft of light from a window or floodlight falls on the image. Images may then appear washed out and less vibrant. Direct sunlight may affect touch operation.

### Ambient Heat

Keep the ambient temperature constant and below 35°C (95°F). Keep the display away from heating and / or air conditioning vents.

## Ventilation

If you are mounting the display in an enclosure, leave sufficient space on all sides between it and surrounding objects, as shown in Figure 3-1. This allows heat to disperse, maintaining the proper operating temperature.

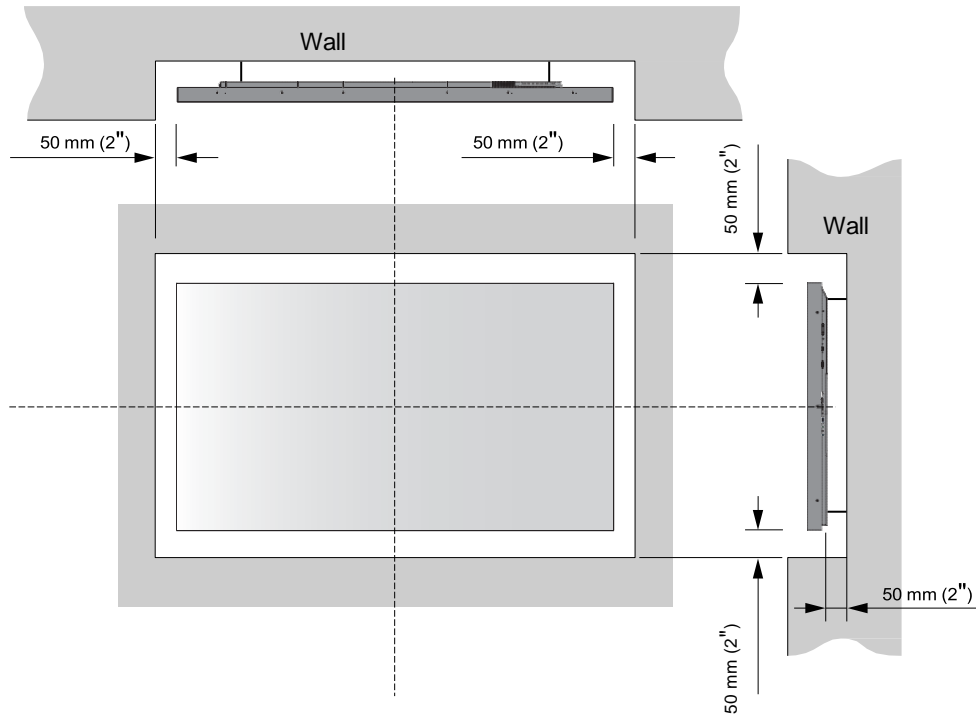

**Figure 3-1. Ventilation Requirements for Enclosure Mounting**

## Mounting the Display

You can mount the display on a wall.

If you do decide to wall-mount the display, ensure that the wall-mount bracket is installed according to the instructions included with it. The wall must be capable of supporting a redundant weight factor three (3) times the weight of the display, or be reinforced.

We recommend that this be done by a custom installation specialist.



**NOTE** Use only the approved wall-mount kit designed for your display.

## Connections to the Display

Proceed as follows to connect the display to your video sources, external controller(s) – if present – and AC power.

When connecting your equipment:

- Turn off all equipment before making any connections.
- Use the correct signal cables for each source.
- For best performance and to minimise cable clutter, use high-quality cables that are only as long as necessary to connect two devices. (Don't use a 7m cable when a 1.8m cable will suffice.)
- Ensure that the cables are securely connected. Tighten the thumbscrews on connectors that have them.

## Connecting a Control System or PC:

### RS232 Connection

Use a straight-through RS-232 cable with a 9-pin male connector to connect a PC or control/ automation system (if present) to the RS-232 port on the display; see **Figure 3-2**.

For more information about using this connection, refer to **External Control** on page 54.

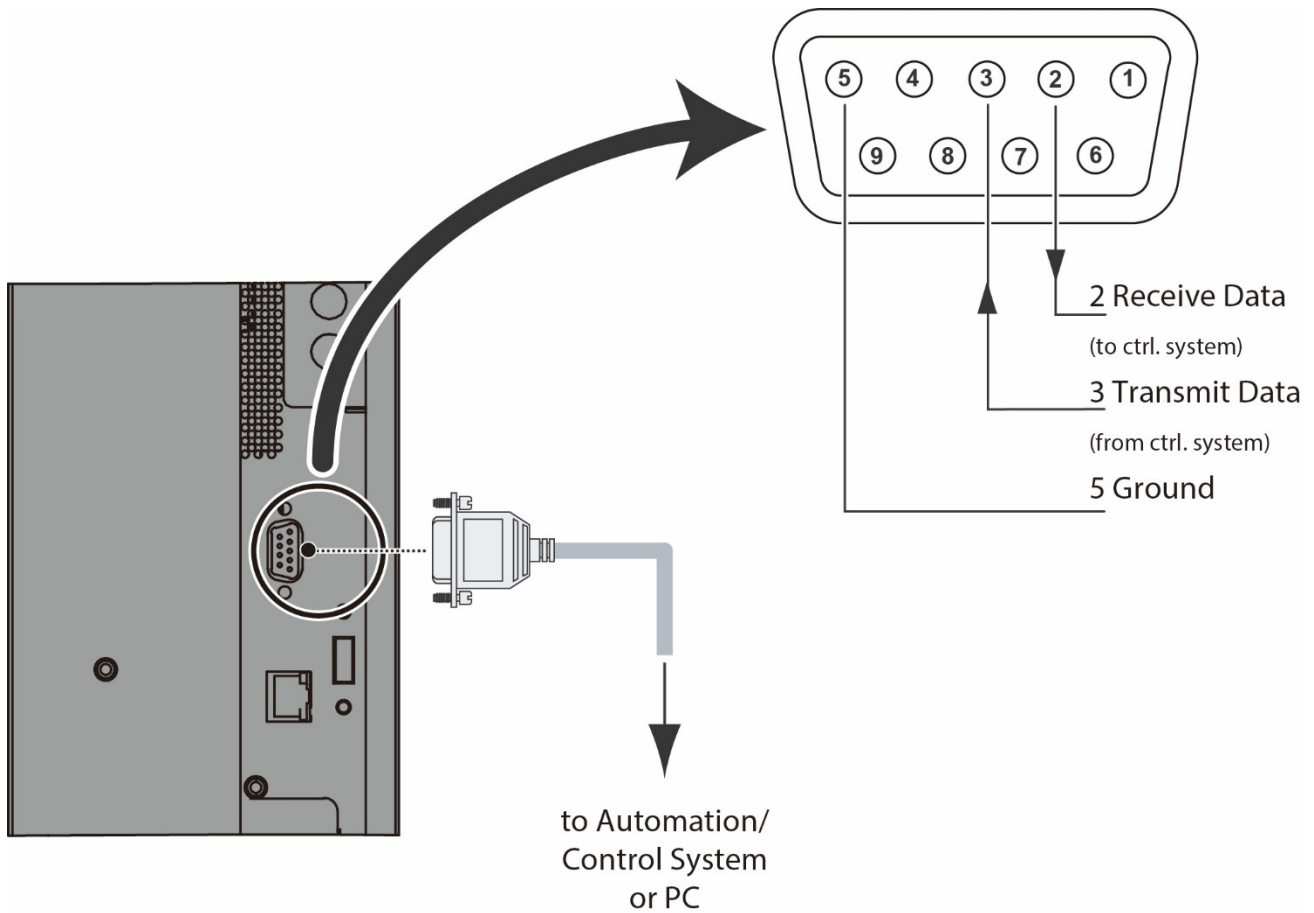
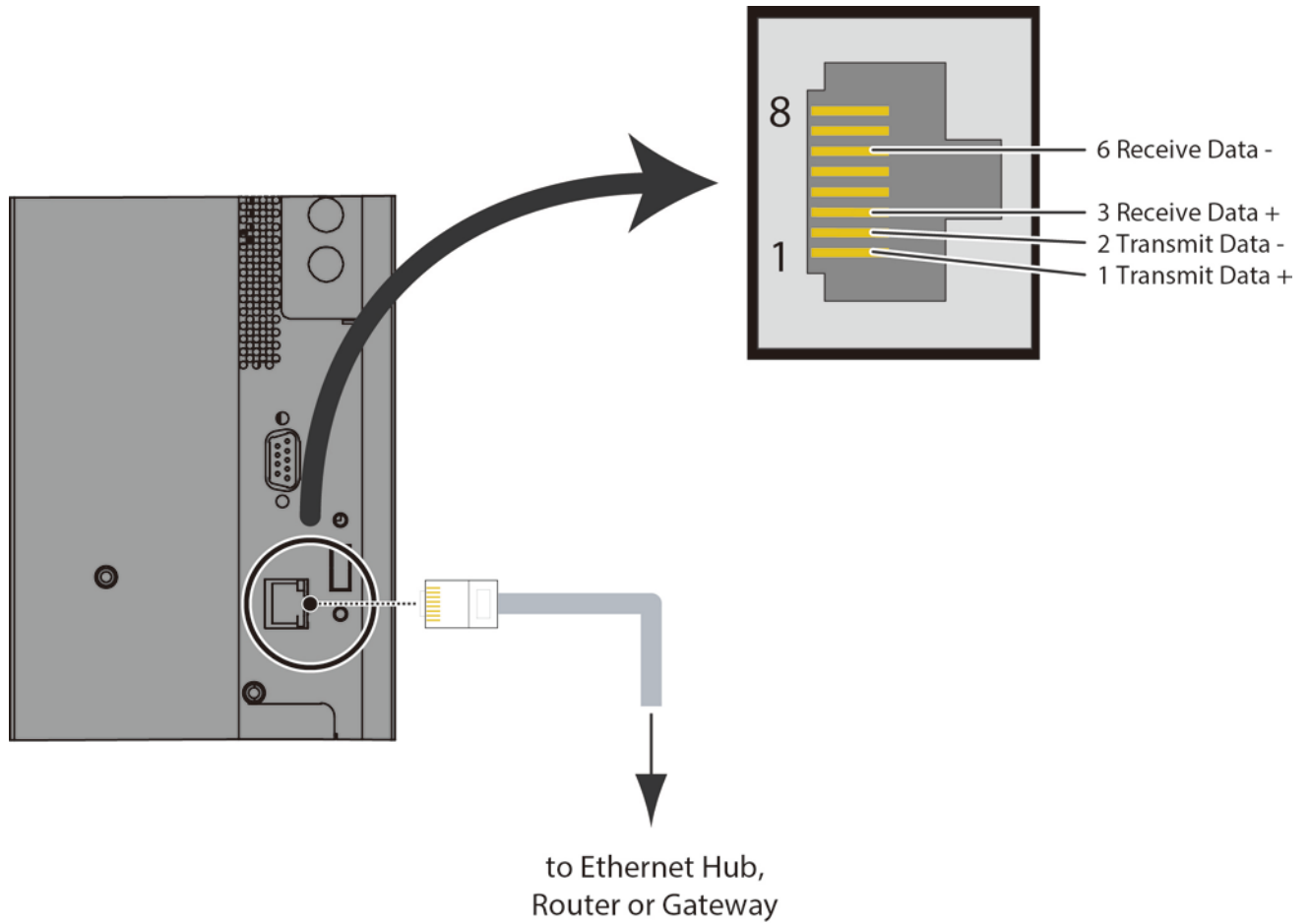

**Figure 3-2. RS-232 Control System Connection**

## Ethernet Connection

Use a standard Ethernet cable with an RJ-45 male connector to connect a PC or control/automation system (if present) to the Ethernet port on the display.

For more information about using this connection, refer to **External Control** on page 54.

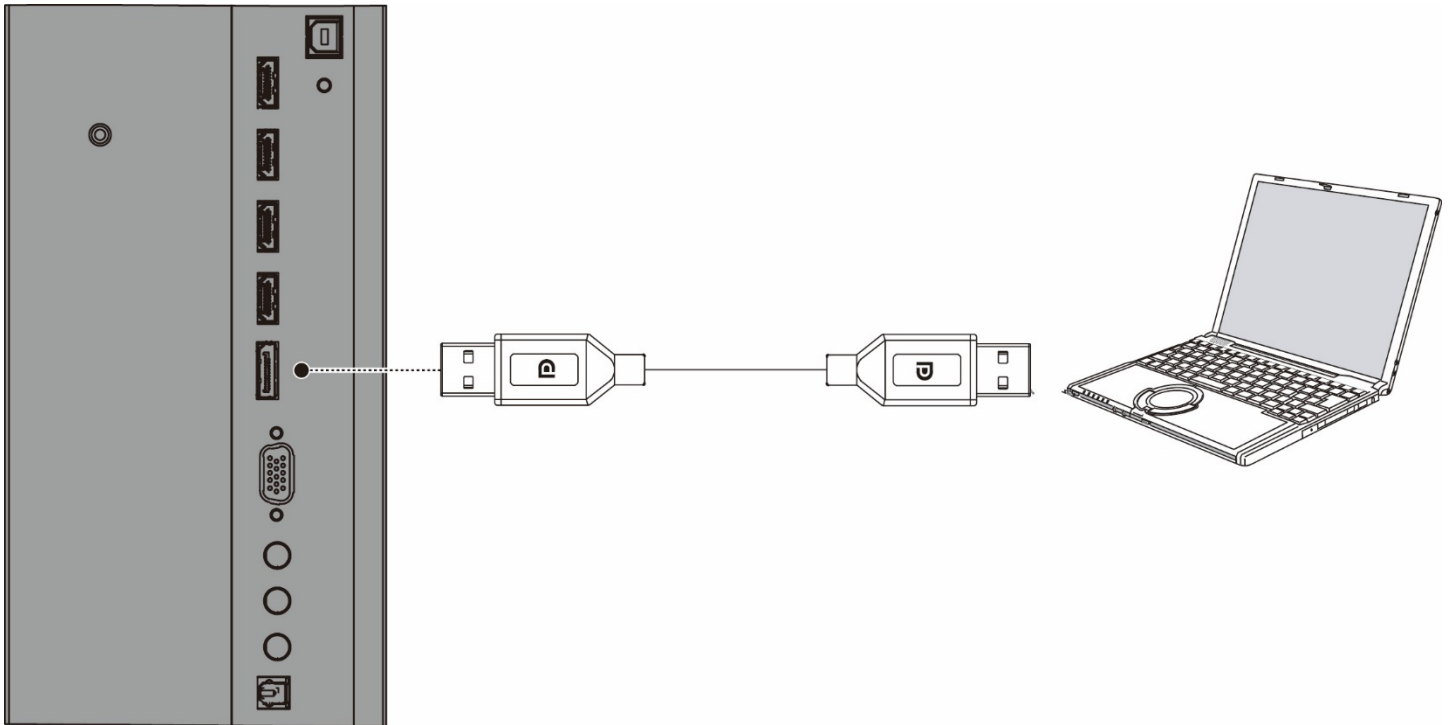

**Figure 3-3. Ethernet Connection**

## Connecting Source Components to the Display

Connect your video sources to the display as shown and described in the sections that follow.

**DisplayPort Source Connection:** See Figure 3-4.



**Figure 3-4. DisplayPort Source Connection**

**HDMI Source Connections:** See Figure 3-5.



**TIP** Use the HDMI inputs whenever possible. This ensures the highest video quality because the signal is carried in the digital domain throughout the entire signal path, from source component output into the display.



**NOTE** This display supports the VESA Display Data Channel (DDC) standard. This standard provides "Plug and Play" capability; the display and a VESA DDC-compatible computer communicate their setting requirements, allowing for quick and easy setup.

In order for Plug and Play to work correctly, you must turn on the display before you turn on the connected computer.

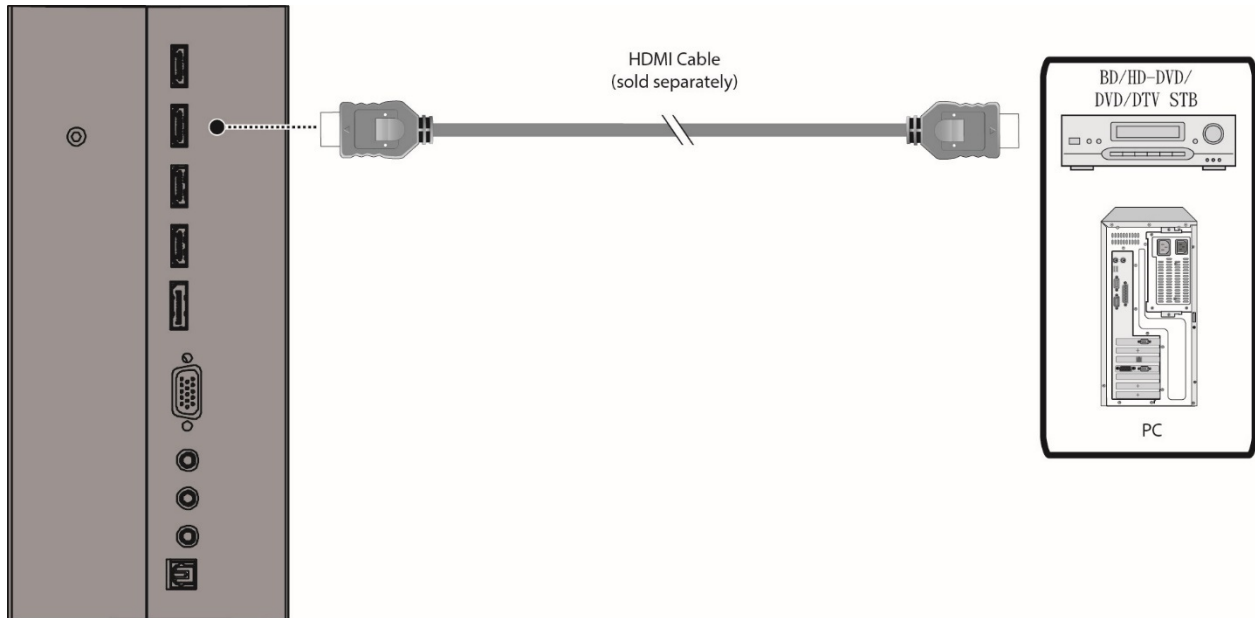

**Figure 3-5. HDMI Source Connections**



**VGA Source Connection:** Connect a personal computer or other RGB source to the VGA input as shown in Figure 3-6.



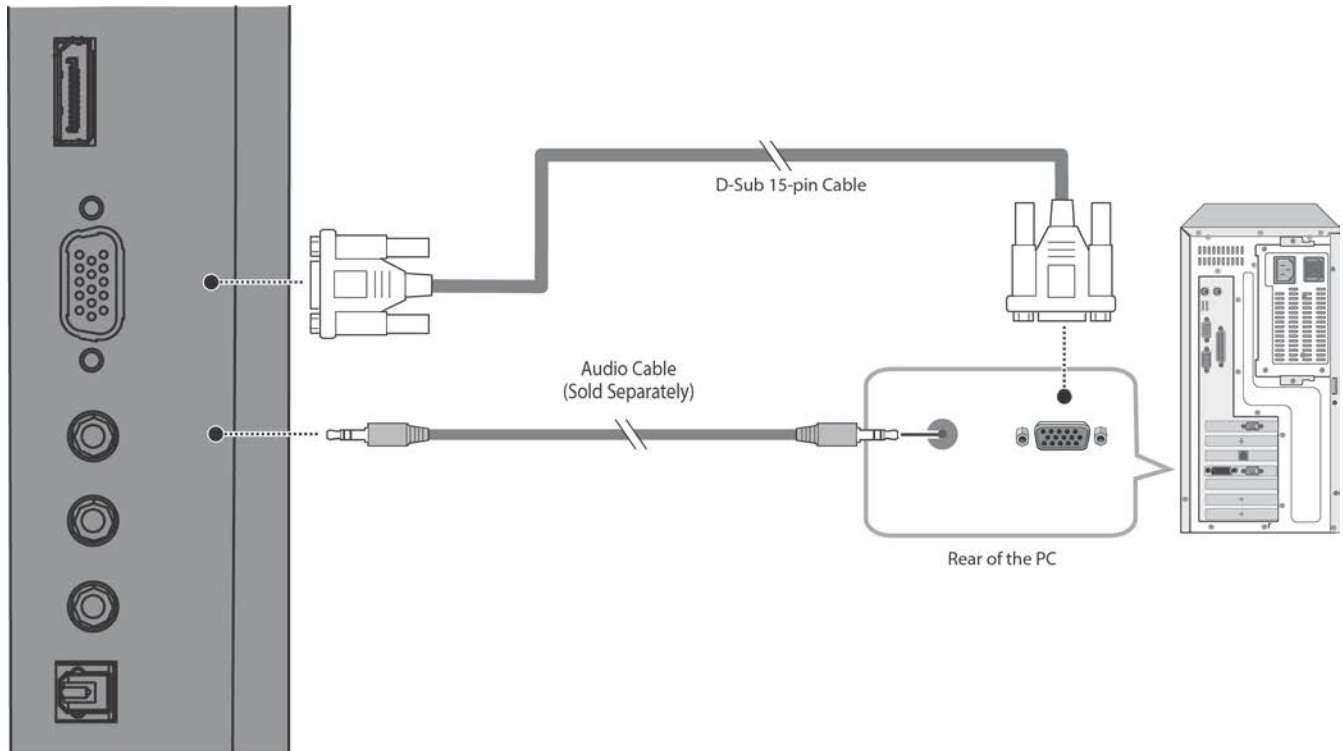

**NOTE** Refer to **Supported Timings** on page 69 for a list of compatible input signals.



**Figure 3-6. VGA Source Connections**

## Turning on the Power

1. Turn on your source components.
2. Plug the female end of the supplied power cord into the AC receptacle on the side of the display (AC 100V ~ 240V). See Figure 2-2.
3. Connect the other end to your AC power source.
4. Turn on the main power switch at the side of the display (see Figure 2-1). The power indicator lights orange to indicate that the display is in "standby" mode.
5. Press the power button (  ) on the remote control to turn on the display or press the power button (  ) on the keypad.
6. After a brief warm-up period, the display will display an image.



**NOTE** If there's no input signal for a period of time, the display will automatically go into power saving (sleep) mode.



## Changing the OSD Language

The display OSD language is initially set to English, but can also display the menus in different languages.

To change the OSD language:

1. Press MENU.
2. Select Basic Settings from the Main Menu.
3. Select OSD Language from the Basic Settings Menu.
4. Press ◀ or ▶ to select the desired language and press ENTER. The change takes effect immediately.

## Enabling the Touch Screen

Before setting up your display to support touch screen capability, ensure that:

- The touch screen controller host computer is turned off.
- The display is turned on.
- The video output from the computer is connected to a video input on the display. See Figure 3-4, Figure 3-5 or Figure 3-6.

### Connecting the Touch Screen Controller Host Computer to the Display

1. Connect the signal cable with display, and then turn on the display.
2. Connect the USB cable with display and the computer; connect one side of USB cable (Type-B USB connector) on the display side.
3. Connect the other side of USB cable (Type-A USB) to the USB port on computer. See picture below.
4. Then turn on the computer.
5. When USB cable connected, then wait for 5 seconds and the touch function is ready to go. It can be activated by pen, finger, or any other pointer.

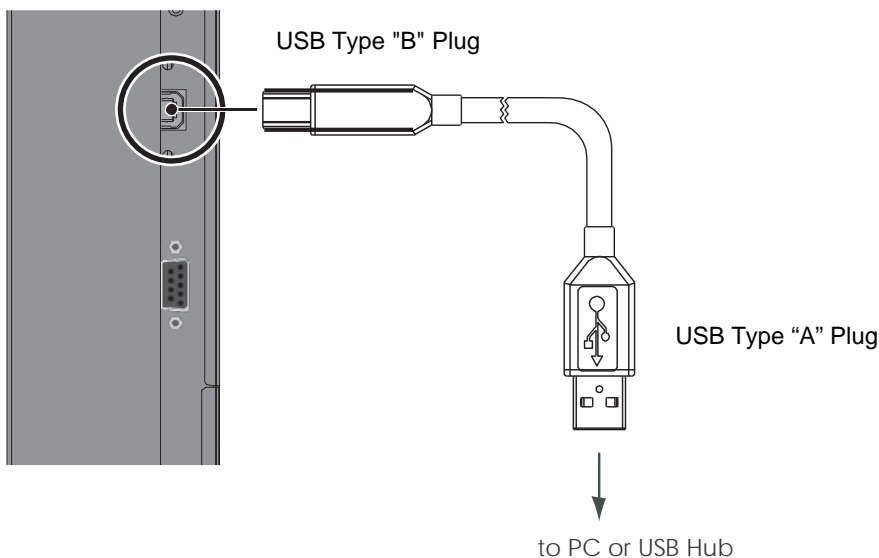
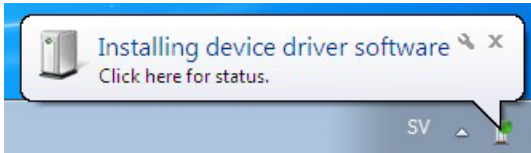

**Figure 3-7. Touch Screen Controller (USB) Connection**

## Software Installation

This driver is not needed for any touch functionality, but is needed in order to perform firmware upgrade.

### Automatic Driver Installation



If the automatic driver installation starts, please allow it to run until completion in order to not disrupt the automatic process. Note that the icon may be hidden in the notification area, and that the procedure may take several minutes.

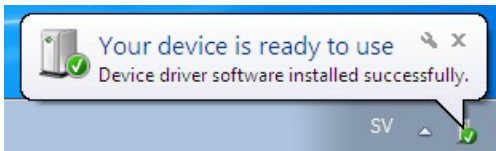

Clicking on the pop-up ballon at this point would show

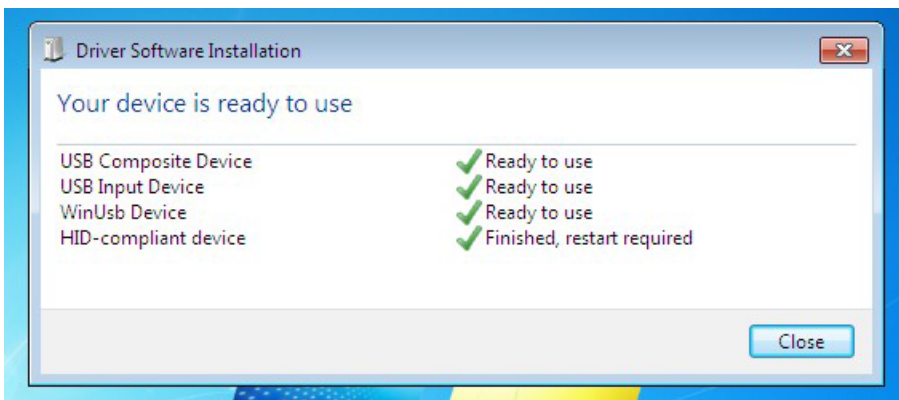

Fully expanded, the view in the Device Manager should look like this (View --> Devices by connection):

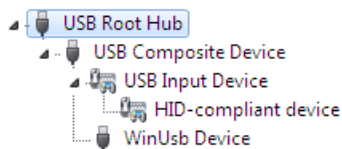

If the automatic installation fails to find the driver, or if automatic driver installation is disabled, or if there is no Internet connection, this is what you will typically see when connecting a FlagFrog touch device.

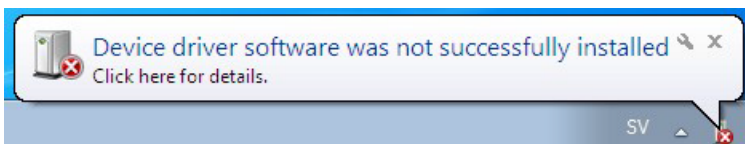

Clicking on the pop-up ballo would show

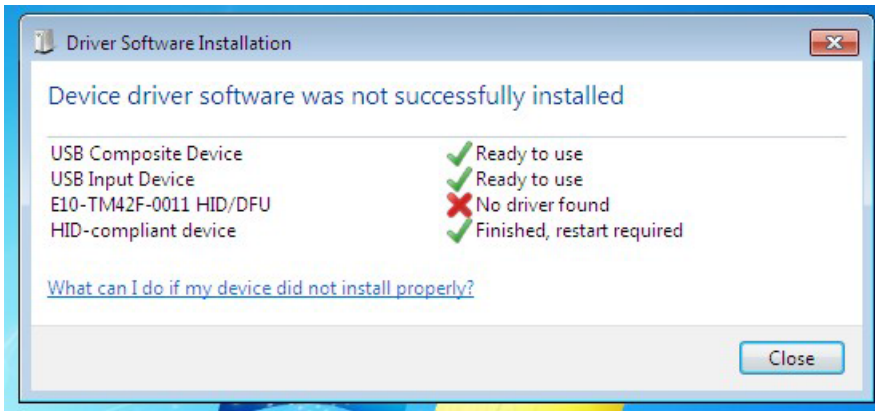

In the Device Manager, the view would be (again, use View --> Devices by connection):

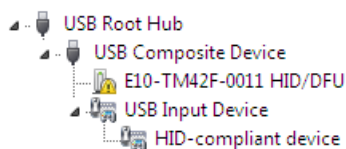

In this case, please proceed with Manual Driver Installation.

## Manual Driver Installation

If the automatic driver installation failed for any of the reasons listed above, or if you would like to install the driver without having a FlatFrog touch device connected to the computer, the driver can be installed manually.

The driver provided with this upgrade package was downloaded from <http://catalog.update.microsoft.com> (requires Internet Explorer) and is called "Microsoft – Other hardware – WinUsb Device" (version 1.1.0.0 from 2012-08-30).

## Manual Driver Installation - Device Connected

1. Extract the firmware upgrade .zip file (right-click --> Extract all...) to the Desktop.
2. Open the Device Manager and locate the "HID/DFU" device with the yellow exclamation mark.
3. Right-click and select "Update Driver Software..."

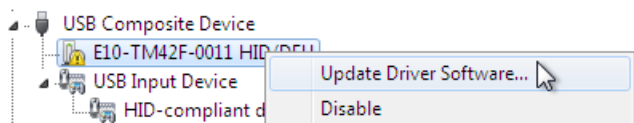

4. Select "Browse my computer for driver software" and select the extracted folder from step 1 and follow the instructions.

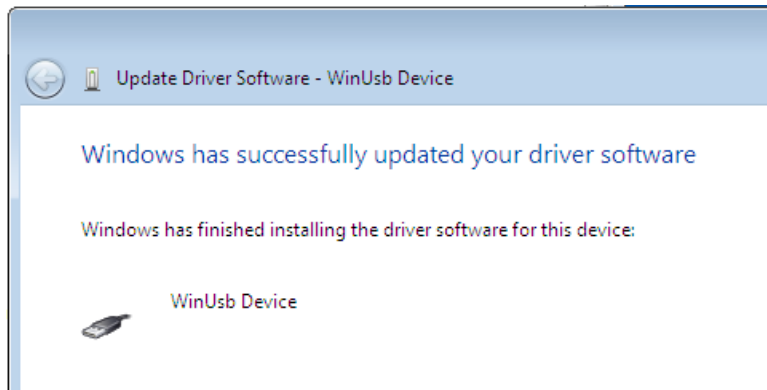

5. If step 4 was unsuccessful, then Windows failed to automatically associate the driver with the device.

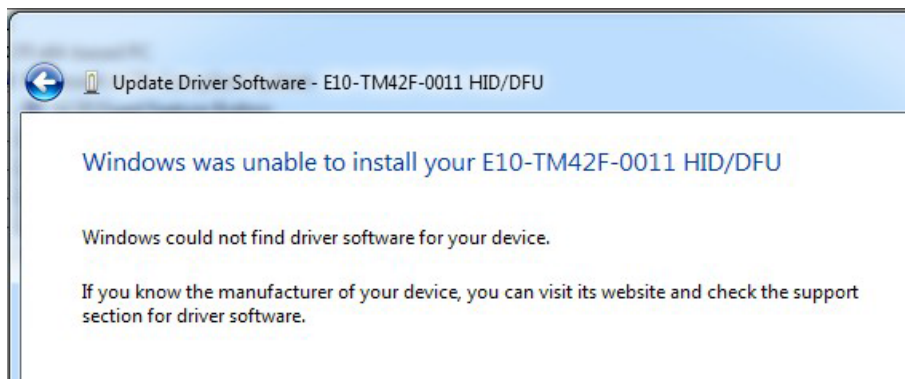

6. Choose "Let me pick from a list if device drivers on my computer" in step 4, scroll all the way down to "Universal Serial Bus devices" and click Next.

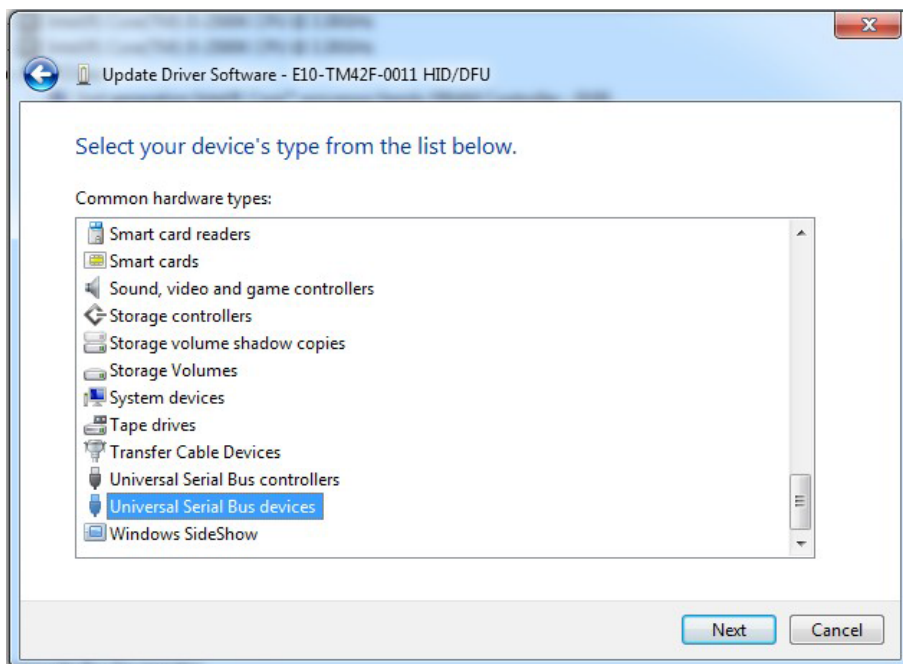

7. Select the WinUsb device driver, and click Next. (If the WinUsb device driver is not in the list, please follow the steps under "Manual Driver Installation - Device Not Connected" first).

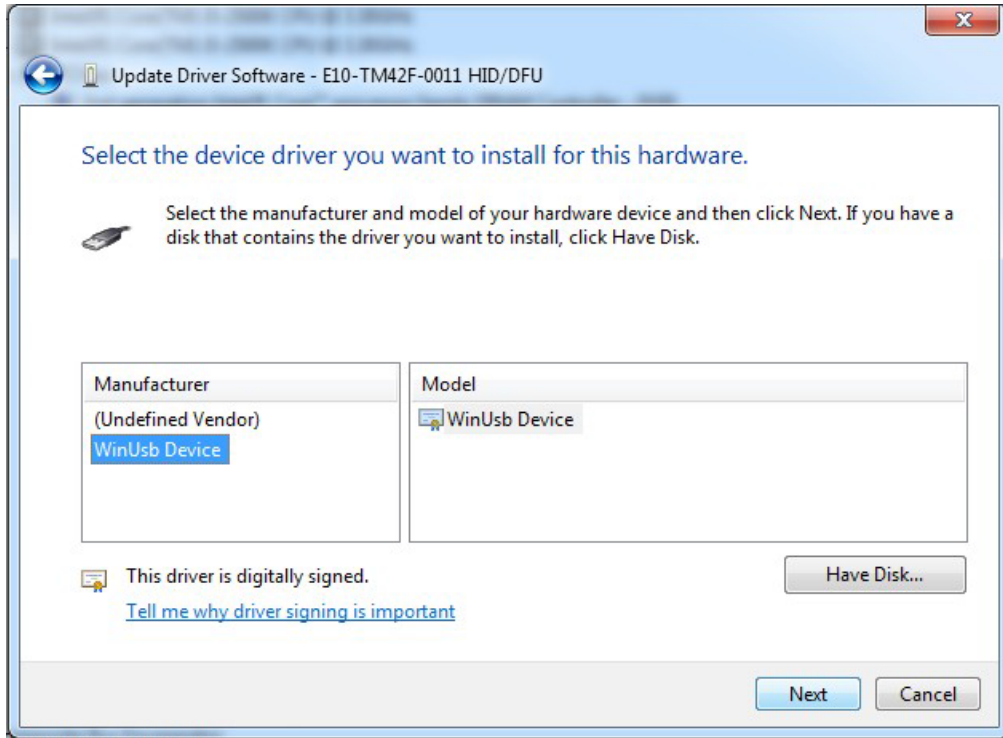

### Manual Driver Installation - Device Not Connected

1. Extract the firmware upgrade .zip file (right-click --> Extract all...) to the Desktop.
2. Navigate to the "support" folder.
3. Right-click on the `install_driver.bat` file and select "Run as administrator" and follow the instructions.

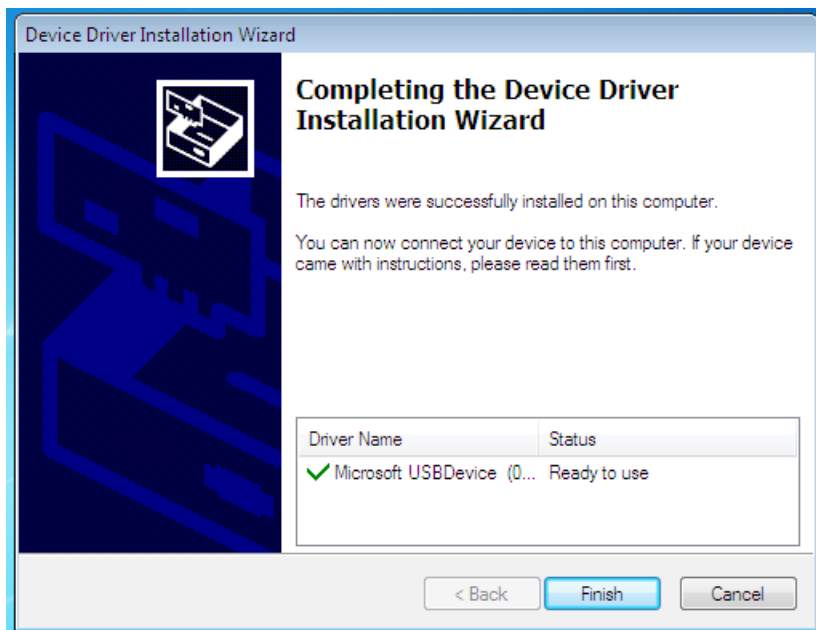

# 4. Operation

## Using the On-Screen Menus

To display the on-screen menus, press MENU on the remote control (Figure 2-3) or built-in keypad (Figure 2-1).

To select a sub-menu, use the ▲ and ▼ buttons to highlight it. Then, press ► to enter that sub-menu.

To select a menu item, use the ▲ and ▼ buttons to highlight it. Then, press ◀ or ▶ to adjust that setting and press ENTER.

The OSD menus are arranged hierarchically, as shown in Figure 4-1. Depending on the selected input source and signal characteristics, some menu options may not be available.

Main Menu	SubMenu	Value
Input	Main Input	VGA; DisplayPort; HDMI1; HDMI2; HDMI3; HDMI4; OPS; Front HDMI; PC
	AutoScan	Off; Main; PxP; All
	PiP Mode	Off; PiP; PbP; 3Window; 4Window
	Sub1 Input	VGA; DisplayPort; HDMI1; HDMI2; HDMI3; HDMI4; OPS; Front HDMI; PC
	Sub2 Input	(same as above)
	Sub3 Input	(same as above)
	PiP Size	Small; Mid; Large
	PiP Position	TopR; TopL; BotR; BotL
	Swap	
	Rename Source	Rename input sources.
Picture	Picture Format	<b>Main:</b> Full Screen/Letterbox/ 4:3/1:1;
	Scheme	<b>User,</b> Vivid, Cinema, Game, Sport
	Contrast	0, 1, 2, ..., <b>50</b> , ....100
	Brightness	0, 1, 2, ..., <b>50</b> , ....100
	Sharpness	0, 1, 2, ..., <b>50</b> , ....100
	Hue	0, 1, 2, ..., <b>50</b> , ....100
	Saturation	0, 1, 2, ..., <b>50</b> , ....100
	Backlight	0, 1, 2, ..., 50, ..., <b>80</b> , ....100
	Colour Temp & Gamma	5000K; 6500K; 7500K; <b>9300K</b> ; User; off; 2.2
	HDMI RGB Range	Auto; Full; Limited
Audio	Volume	0~100
	Treble	-6~6
	Bass	-6~6
	Balance	-6~6
	Internal Speaker	On; Off
	Audio Source	Line-In ; DisplayPort ; HDMI1 ; HDMI2 ; HDMI3 ; HDMI4 ; OPS; Front HDMI; PC

Main Menu	SubMenu	Value
OSD Settings	Horizontal	0~100
	Vertical	0~100
	Transparency	Off; 1~4
	OSD Timeout	5s; 10s; 20s; 30s; 60s
	Language	<b>English</b> , French, German, Dutch, Hungarian, Slovenian, Serbian, Croatian, Danish
	Splash Screen	On; Off
Setup	Auto Adjustment	
	H.Position	0~100
	V.Position	0~100
	Phase	0~100
	Clock	0~100
	Zoom	10 steps
	Power LED	On; Off
	Real Time Clock	User Mode; Workday Mode; Everyday Mode
	Win10 PC Power Mode	Auto, Manual, Off
Adv. Setup	Smart Light Control	Off; DCR; Light Sensor
	IRFM	On; Off
	Noise Reduction	<b>Off</b> ; Low; Medium; High
	Wake Up From Sleep	VGA Only; Digital, RS232. Ethernet; Never Sleep
	DP Ver.	1.1; 1.2
	EDID Setup	HDMI: 4K2K/1080P; DP: 4K2K/1080P
	Touch Control	Auto; OPS; USB Touch 1; USB Touch 2; PC
	Firmware Update	
	Factory Reset	
Communication	RS232 Baud Rate	<b>115200</b> ; 38400; 19200; 9600
	Enable Network	Yes; No
	IP Address Settings	Please refer to <a href="#">Communication Menu</a> section for details
	Power Status Alert	Yes; No
	Source Status Alert	Yes; No
	Signal Lost Alert	Yes; No
	Load Default	Yes; No
	Device MAC	Shows the MAC address of the device
Information	(Timing info)	Shows the name of input source
	PC Power Status	Shows the power status of PC
	Firmware Version	Shows the firmware version of the monitor
	SubMCU Version	Shows the firmware version of the monitor
	Serial Number	Shows the Serial Number of the monitor



**NOTE**

Default settings appear in bold type.

**Figure 4-1. OSD Menu Structure**



## Input Menu

This menu is used for selecting the main input source (Main) and up to three Picture-in-Picture input sources (Sub1, Sub2 and Sub3). Up to four sources can be displayed at the same time.

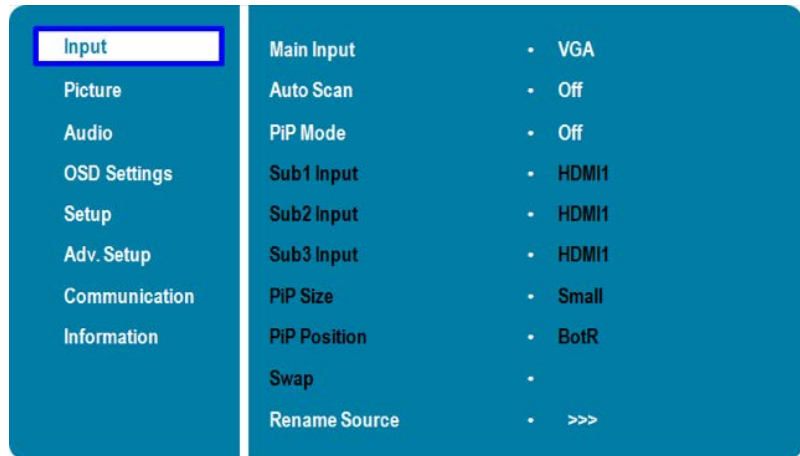

### Main Input

Select the main input source

**Options:** VGA, DisplayPort, HDMI1, HDMI2, HDMI3, HDMI4, OPS, Front HDMI, PC

### Auto Scan

Select whether the display will automatically scan for a main input source

**Options:** Off, Main, PnP, All

### PIP Mode

Select the PiP (Picture-in-Picture) mode

**Options:** Off, PiP, PnP, 3Window, 4Window

### Sub1 Input

Select the source for the primary PiP window

**Options:** VGA, DisplayPort, HDMI1, HDMI2, HDMI3, HDMI4, OPS, Front HDMI, PC

*Note: This function is only available when PiP Mode is set to PiP, PnP, 3Window or 4Window*

### Sub2 Input

Select the source for the secondary PiP window

**Options:** VGA, DisplayPort, HDMI1, HDMI2, HDMI3, HDMI4, OPS, Front HDMI, PC

*Note: This function is only available when PiP Mode is set to 3Window or 4Window*

### Sub3 Input

Select the source for the tertiary PiP window

**Options:** VGA, DisplayPort, HDMI1, HDMI2, HDMI3, HDMI4, OPS, Front HDMI, PC

*Note: This function is only available when PiP Mode is set to 4Window*

### PIP Size

Select the size of the primary PiP window

**Options:** Small, Mid, Large

*Note: This function is only available when PiP Mode is set to PiP*

### PIP Position

Set the position of the primary PiP window

**Options:** TopR, TopL, BotR, BotL

*Note: This function is only available when PiP Mode is set to PiP*

## Swap

Swap the main input source with the primary PiP source

*Note: This function is only available when PiP Mode is set to PiP, PbP, 3Window or 4Window*

## Rename Source

Rename the input source.

Press ENTER to select the input source you want to rename. Using ▲ or ▼ to change the character and ◀ or ▶ to move forward/back a position. Then press MENU and ENTER to save the name. The name can be up to eight characters (0~9, A~Z, a~z).

## Picture Menu

This menu is used for making common image adjustments.

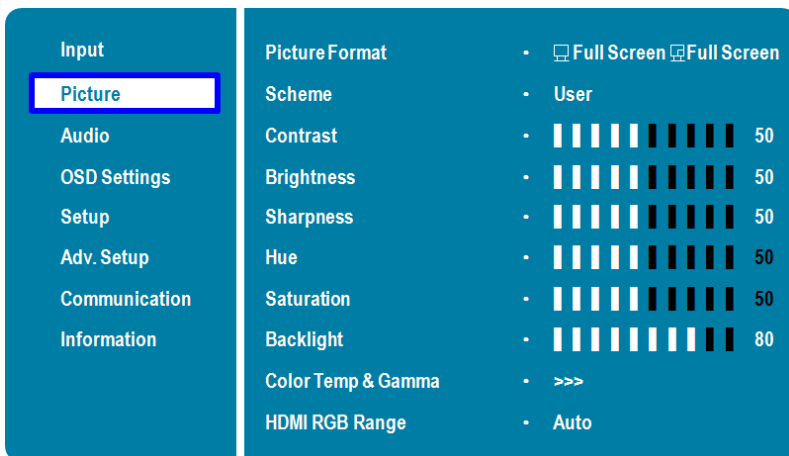

### Picture Format

Adjust the picture format of the screen

**Options:** Full Screen, Letterbox, 4:3, 1:1; **Default:** Full Screen

### Scheme

Press ◀ or ▶ to select one of the following:

**Options:** User, Vivid, Cinema, Game, Sport; **Default:** User

### Contrast

Increase or decrease the contrast of picture.

Press ◀ or ▶ to select the desired level, and then press ENTER.

**Range:** 0~100; **Default:** 50

### Brightness

Increase or decrease the brightness of picture.

Press ◀ or ▶ to select the desired level, and then press ENTER.

**Range:** 0~100; **Default:** 50

### Hue

Increase or decrease the green hue.

Press ◀ or ▶ to select the desired level, and then press ENTER.

**Range:** 0~100; **Default:** 50

*Note: This function is not available when displaying PC or graphics sources*

## Saturation

Adjust the brilliance and brightness.

Press ◀ or ▶ to select the desired level, and then press ENTER.

**Range:** 0~100; **Default:** 50

*Note: This function is not available when displaying PC or graphics sources*

## Backlight

Increase or decrease the intensity of the LCD backlight.

Press ◀ or ▶ to select the desired level, and then press ENTER.

**Range:** 0~100; **Default:** 80

## Gamma

Select gamma curve

**Options:** Off, 2.2; **Default:** 2.2

## Colour Temp

Select a colour temperature, or select User to make RGB adjustments.

**Options:** User, 5000K, 6500K, 7500K and 9300K; **Default:** 9300K

## HDMI RGB Range

Select an RGB range for the HDMI input.

**Options:** Auto, Full, Limited; **Default:** Auto

## Colour Temperature Settings



## Red Gain

Set Colour Temperature to "User Mode" in order to adjust this setting.

**Range:** 0~100; **Default:** 100

## Green Gain

Set Colour Temperature to "User Mode" in order to adjust this setting.

**Range:** 0~100; **Default:** 100

## Blue Gain

Set Colour Temperature to "User Mode" in order to adjust this setting.

**Range:** 0~100; **Default:** 100

## Red Offset

Set Colour Temperature to "User Mode" in order to adjust this setting.

**Range:** 0~100; **Default:** 50

## Green Offset

Set Colour Temperature to "User Mode" in order to adjust this setting.

**Range:** 0~100; **Default:** 50

## Blue Offset

Set Colour Temperature to “User Mode” in order to adjust this setting.

**Range:** 0~100; **Default:** 50

## Audio Menu

This menu is used for adjusting volume settings.

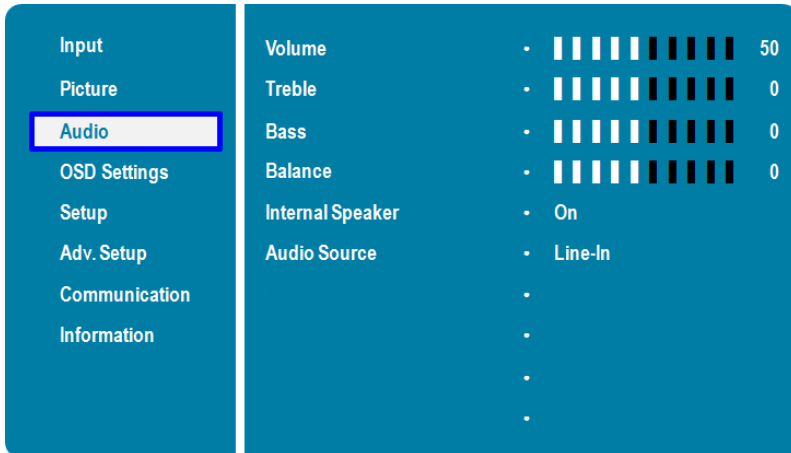

### Volume

Adjust the sound. Press ◀ or ▶ to select the desired level, and then press ENTER.

**Range:** 0~100; **Default:** 50

### Treble

Adjust the sound in high tones (treble). Press ◀ or ▶ to select the desired level, and then press ENTER.

**Range:** -6~6; **Default:** 0

### Bass

Adjust the sound in low tones (bass). Press ◀ or ▶ to select the desired level, and then press ENTER.

**Range:** -6~6; **Default:** 0

### Balance

Adjust the balance of the left and right speakers. Press ◀ or ▶ to select the desired level, and then press ENTER.

**Range:** -6~6; **Default:** 0

### Internal Speaker

Turn the internal speaker on or off

**Default:** On

### Audio Source

Select the audio source for the Main input

**Options:** Line-In, DisplayPort, HDMI1, HDMI2, HDMI3, HDMI4, OPS, Front HDMI, PC

**Default:** Line-in

## OSD Settings Menu

This menu is used to make initial set-up adjustments to the OSD (On-Screen Display) menu and other on-screen messages.

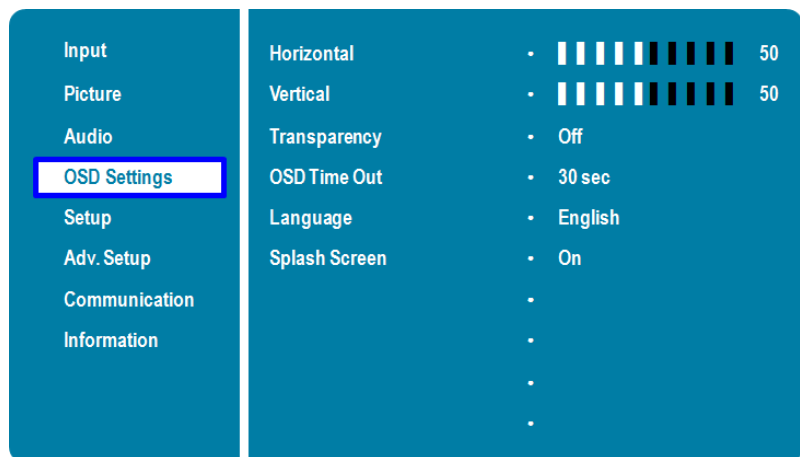

### Horizontal

Adjust the horizontal position of the OSD menu. Press ◀ or ▶ to select the desired level, and then press ENTER.

**Range:** 0~100; **Default:** 50

### Vertical

Adjust the vertical position of the OSD menu. Press ◀ or ▶ to select the desired level, and then press ENTER.

**Range:** 0~100; **Default:** 50

### Transparency

Adjust the transparency of the OSD menu. Press ◀ or ▶ to select the desired level, and then press ENTER.

**Range:** Off, 1~4; **Default:** Off

### OSD Time Out

Adjust the time in seconds before the OSD menu disappears. Press ◀ or ▶ to select the desired level, and then press ENTER.

**Options:** 5s, 10s, 20s, 30s, 60s

**Default:** 30s

### Language

Select the OSD language

**Options:** English, French; German; Dutch; Hungarian; Slovenian; Serbian; Croatian; Danish

**Default:** English

### Splash Screen

Select whether a splash screen appears when the monitor is powered up

**Options:** On, Off

**Default:** On

## Setup Menu

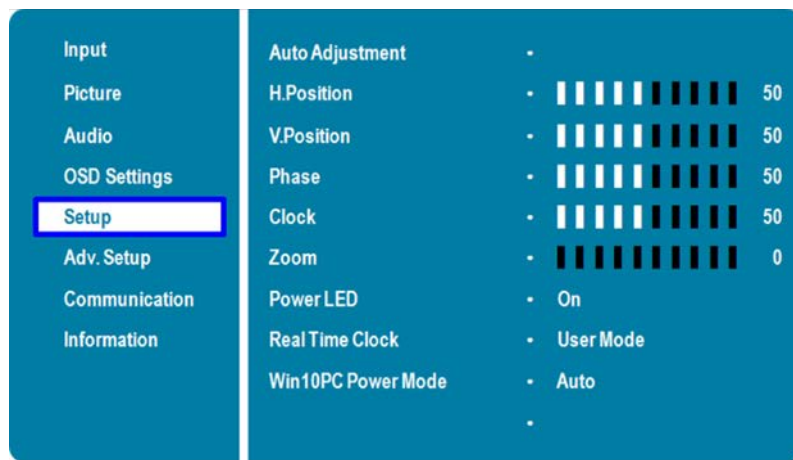

### Auto Adjustment

Force the display to reacquire and lock to the input signal (VGA source only). This is useful when the signal quality is marginal. Note: This feature does not continually reacquire the signal.

**Options:** No, Yes; **Default:** No

### H. Position

Adjust the horizontal position of the image (VGA source only). Press ◀ or ▶ to select the desired level, and then press ENTER.

**Range:** 0–100; **Default:** 50

### V. Position

Adjust the vertical position of the image (VGA source only). Press ◀ or ▶ to select the desired level, and then press ENTER.

**Range:** 0–100; **Default:** 50

### Phase

Adjust the phase of the displayed signal (VGA source only). Press ◀ or ▶ to select the desired level, and then press ENTER.

**Range:** 0–100

### Clock

Adjust the clock of the displayed signal (VGA source only). Press ◀ or ▶ to select the desired level, and then press ENTER.

**Range:** 0–100

### Zoom

Adjust the zoom (overscan) of the image. Press ◀ or ▶ to select the desired level, and then press ENTER.

**Range:** 10 steps

### Power LED

Enable or disable the status LED

**Options:** On, Off; **Default:** On

### Real Time Clock

Set the internal clock of the display, and to power on and off the display at preset times if desired.

**Options:** User mode, Workday mode, Everyday mode

**Default:** User mode

### Win10 PC Power Mode

Set Win10 PC power mode.

**Options:** Auto, Manual, Off

**Default:** Auto

## Advanced Setup Menu

Input	Smart Light Control	• Off
Picture	IRFM	• Off
Audio	Noise Reduction	• Off
OSD Settings	Wake Up From Sleep	• VGA Only
Setup	DP Ver.	• 1.2
<b>Adv. Setup</b>	EDID Setup	• DP 4K2K
Communication	Touch Control	• Auto
Information	Firmware Update	• >>>
	Factory Reset	• >>>
		•

### Smart Light Control

Enable dynamic contrast (DCR) or ambient light sensor

**Options:** Off, DCR, Light Sensor; **Default:** Off

### IRFM

Create slight frame motion to help avoid image retention

**Options:** On, Off; **Default:** Off

### Noise Reduction

Reduce random noise in the video content

**Options:** Off, Low, Medium, High; **Default:** Off

### Wake Up From Sleep

**Options:** VGA Only, Digital, RS232, Ethernet; Never Sleep

**Default:** VGA Only

### DP Ver.

Select DisplayPort version of the DisplayPort inputs

**Options:** 1.1, 1.2

*Note: DisplayPort 1.2 is the more modern standard and supports 3840x2160 @ 60 Hz resolution. However, sometimes DisplayPort 1.1 is needed for compatibility with older graphics cards.*

### EDID Setup

Select EDID (Extended Display Identification Data) of the HDMI and DisplayPort inputs

**Options:** 1080p, 4K2K

*Note: Use the 1080p setting for the broadest support of lower resolution sources. Use 4K2K setting to support high resolution sources such as 3840x2160.*

### Touch Control

Select one of the touch connections, or choose auto detection.

**Options:** Auto, OPS, USB Touch 1 (front panel), USB Touch 2 (I/O panel), PC;

**Default:** Auto

### Firmware Update

Plug in the USB flash drive and select Yes to proceed with firmware update.

**Options:** No, Yes; **Default:** No

To start updating firmware, select Yes to continue.

**Options:** No, Yes; **Default:** Yes

### Factory Reset

Restore all settings to their default.

**Options:** No, Yes; **Default:** No

## Wake Up from Sleep

By default, the display will enter power saving (Sleep Mode) if no signal is received for 5 minutes. Normally, the RS-232, DisplayPort, and HDMI inputs are inactive in Sleep Mode, to save power.

To change the behavior of Sleep Mode, change the “**Wake up from Sleep**” setting in the “**Adv. Setup**” menu.

- **VGA Only** (default) – The RS-232, DisplayPort, and HDMI inputs are inactive when the display is in sleep mode. The display will wake up when it receives a signal at the VGA input.
- **Digital, RS232, Ethernet** – The RS-232, DisplayPort and HDMI inputs stay active when the display is in sleep mode. The display will wake up when it receives a signal at either of the DisplayPort, HDMI, or RS-232 inputs, or via LAN connection.



## Communication Menu

This menu configures the display's RS232 and Ethernet communication ports.

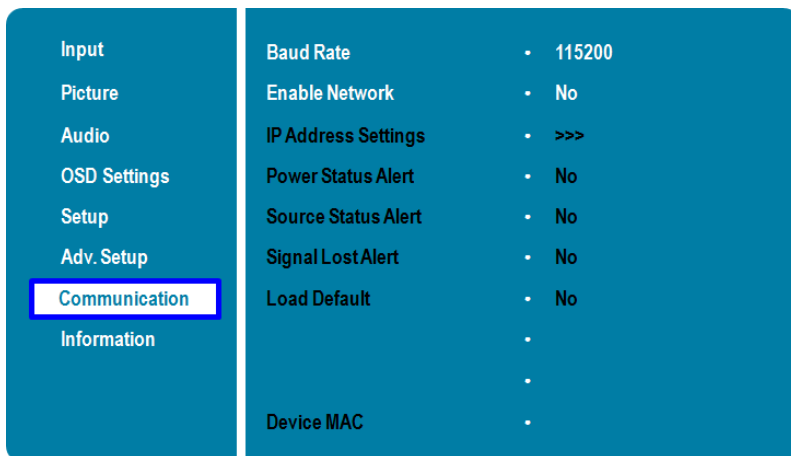

### Baud Rate

Select the baud rate of the display's RS232 port

**Options:** 115200, 38400, 19200, 9600

**Default:** 19200

### Enable Network

Enable the display's built-in Ethernet port

**Options:** No, Yes

**Default:** No

### IP Address Settings

Enable Dynamic IP mode or set the static IP address of the display's Ethernet port

### Power Status Alert

Enable an automatic alert when the display is powered down

**Options:** No, Yes

**Default:** No

### Source Status Alert

Enable an automatic alert when the source is changed

**Options:** No, Yes

**Default:** No

### Signal Lost Alert

Enable an automatic alert when the video signal is lost

**Options:** No, Yes

**Default:** No

### Load Default

Load default communication settings

**Options:** No, Yes

**Default:** No

### Device MAC

Display the MAC address of the device.

## Network Settings

To assign an IP address to your display, access the IP Address Settings Menu in the **Communication Menu**. Consult your system administrator if you do not know how to configure the parameters shown in the menu.

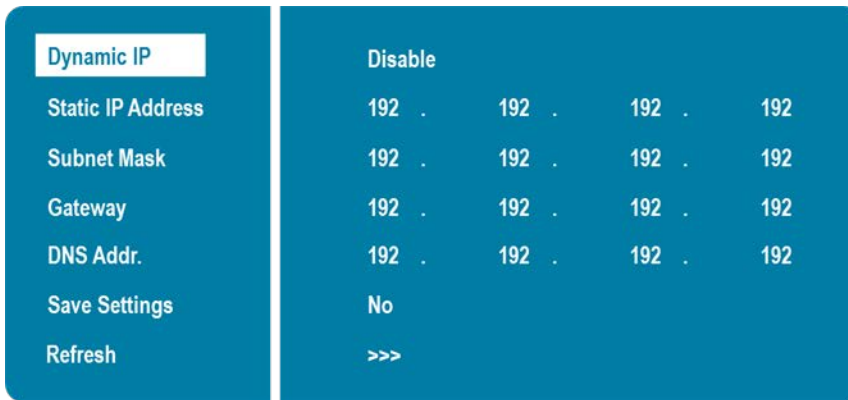

The default settings are shown below.

Item	Setting
DHCP	Disable
IP ADDRESS	192.168.2.1
SUBNET MASK	255.255.255.0
DEFAULT GATEWAY	192.168.2.1
DNS Addr.	192.168.2.1

## Information

This read-only menu provides information on the active sources and the latest firmware version

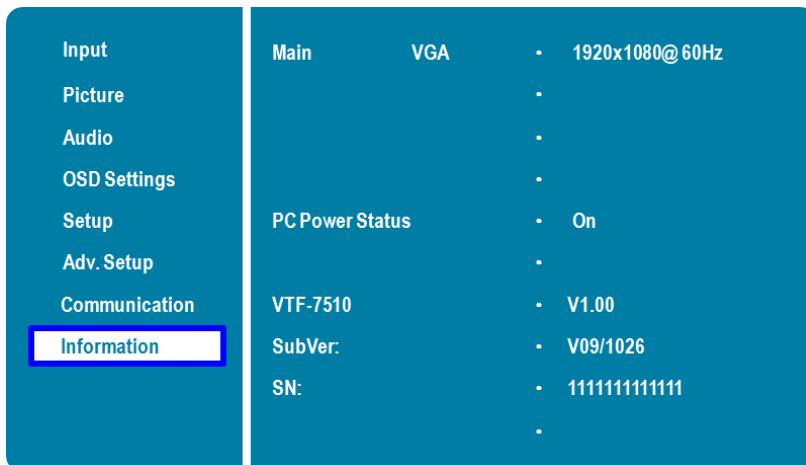

# 5. Maintenance and Troubleshooting

## Maintenance

The AVOCOR Series LED Displays does not require any routine maintenance other than occasional cleaning with a non-abrasive cloth. There are no user-serviceable or replaceable parts. Unless you are a qualified, factory-trained technician, do not attempt to repair or replace any system component yourself. You will void the product warranty if you do so.

## Troubleshooting

Table 5-1 provides some general guidelines for troubleshooting problems you may encounter with the AVOCOR Series LED Display. If the suggested solutions fail to resolve the problem or if you encounter an issue not described here, please contact your dealer.

Table 5-1. Troubleshooting Chart

Symptom	Possible Cause(s)	Solution
<b>The display does not turn on.</b>	The display is not plugged in or the AC outlet is not active.	Ensure that the display is plugged in and that the AC outlet is active.
	The main power switch is off.	Set the main power switch (see Figure 2-1) to the on position.
	The remote control batteries have run out.	Replace the batteries.
<b>The display is on and menus appear, but there is no picture.</b>	Incorrect source selection.	Select the correct source.
	Source component is not turned on.	Turn on the source component.
	Source component is connected incorrectly or not at all.	Check connections from the source component to the display.
<b>The remote control does not work.</b>	The remote control batteries have run out.	Replace the batteries.
	The buttons are locked.	Unlock the buttons by pressing ENTER, ENTER, EXIT, EXIT, ENTER and EXIT, in sequence.
<b>Image geometry is incorrect.</b>	Incorrect aspect ratio selection.	Select a different aspect ratio.

Table 5-1. Troubleshooting Chart (continued)

Symptom	Possible Cause(s)	Solution
The display is jittery or unstable.	Poor-quality or improperly connected source.  The horizontal or vertical scan frequency of the input signal may be out of range for the display.	Ensure that the source is properly connected and of adequate quality for detection.  Correct at the source.
Image is too bright and / or lacks definition in the bright areas of the image.	Contrast is set too high.	Decrease the contrast setting.
Image appears "washed out" and / or dark areas appear too bright.	Brightness is set too high.	Decrease the brightness setting.
Image is too dark.	Brightness and / or Backlight are set too low.	Increase the brightness and / or backlight settings.
Images from an HDMI source do not display.	The resolution and frequency of the video card in the computer are not compatible with the display.  HDMI cable from source to display is either defective or too long.	Select a compatible resolution and vertical frequency (refer to <b>Supported Timings</b> on page 69).  Try a known-good and / or shorter HDMI cable.
Computer images do not display correctly.	The resolution and frequency of the video card in the computer are not compatible with the display  Clock and Phase settings need adjustment.	Select a compatible resolution and vertical frequency (refer to <b>Supported Timings</b> on page 69).  Adjust Clocks and Phase settings (refer to <b>Setup Settings</b> page 46).
Touch screen doesn't work.	Multi-touch controller host computer is not connected correctly.  Host computer hardware or OS incompatibility.	See Figure 3-7.  Refer to <b>Enabling the Touch Screen</b> on page 34.

Should you require assistance with a suspected hardware fault, please contact the support line below. You will require your unit serial number. The operator will attempt to diagnose any fault and will take action as appropriate.

avocor<sup>TM</sup>

US Warranty Support

Tel. 858-266-8363

Email. [service@avocor.com](mailto:service@avocor.com)

# 6. External Control

In addition to using the display keypad or remote control unit, you can control the display using a serial (RS-232) link to send ASCII commands and receive responses to those commands.

You also use discrete infrared (IR) control codes to program a third-party remote control unit. For more information, refer to Using Discrete IR Codes on page 64.

## Serial Communications

The display uses a simple text-based control protocol to take requests from control devices and to provide responses to such devices. This section describes how to send control messages over a serial link between the display and an automation/control system or a PC running a terminal emulation program such as Windows® HyperTerminal or Tera Term.

### RS-232 Connection and Port Configuration

Connect your control system or PC to the RS-232 input of the display as shown in Figure 3-2.

Configure the RS-232 controller or PC serial port as follows: no parity, 8 data bits, 1 stop bit and no flow control. Set the baud rate to 115200, to match that of the display RS-232 port.

### Command and Response Format

Commands sent from an automation/control system or PC to the display must have the following format:

[STX] [IDT] [TYPE] [CMD] ([VALUE] or [REPLY]) [ETX] [CR]

Where:

- [STX] indicates the start of the command data (always 07).
- [IDT] is the display ID (always 01).
- [TYPE] is the command type:
  - 00 = return to host (response from the LCD panel)
  - 01 = read / action
  - 02 = write
- [VALUE] is the parameter setting for the command.
- [REPLY] is the parameter setting for the command, acknowledged by the display in its response to a command.
- [ETX] indicates the end of the command data (always 08).
- [CR] is the ASCII carriage return key (0x0D).

## Command and Response Examples

Here are some examples of serial commands and their responses:

**Table 6-1. Serial Command/ Response Examples**

Description	Command sent to LCD Panel	Response Received from LCD Panel
Turn LCD panel power off.	07 01 02 50 4F 57 00 08	07 01 00 50 4F 57 00 08
Turn LCD panel power on.	07 01 02 50 4F 57 01 08	07 01 00 50 4F 57 01 08
Request LCD panel power status.	07 01 01 50 4F 57 08	07 01 00 50 4F 57 XX 08 (XX = 0 when off or 1 when on)
Set the LCD panel contrast to 30 (1E hex).	07 01 02 43 4F 4E 1E 08	07 01 00 43 4F 4E 1E 08
Reset the LCD panel display settings.	07 01 02 41 4C 4C 00 08	07 01 00 41 4C 4C 00 08
Request LCD panel serial number.	07 01 01 53 45 52 08	07 01 00 53 45 52 S(0)...S(12) 08 S(0) ...S(12) = the serial number in ASCII
Request LCD panel firmware version.	07 01 01 47 56 45 08	07 01 00 47 56 45 S(0)...S(5) 08 S(0)...S(5) = the firmware version in ASCII

## Serial Command List

Table 6-2 lists all supported commands.

**Table 6-2. Serial Commands**

Main Item	Control Item	CMD	Type	Value (DEC)	Reply (DEC)	Content	CMD (HEX)
Power Control and Input Source	Power Control	POW	W/R	00	00	Off (soft power)	50 4F 57
				01	01	On (soft power)	
	IPC Control	IPC	W/R	00	00	Off	49 50 43
				01	01	On	
	Input Source	MIN	W/R	00	00	VGA	4D 49 4E
				09	09	HDMI 1	
				10	10	HDMI 2	
				11	11	HDMI 3	
				12	12	HDMI 4	
				13	13	Displayport	
14				14	IPC/OPS		
17				17	HDMI 5 (Front Panel)		
18	18	Media Player (Win/Android)					
Display Adjustment	Display Adjustment	BRI	W/R	0~100	0~100	Back Light Brightness	42 52 49
		BRL	W/R	0~100	0~100	Digital Brightness Level	42 52 4C
		BLC	W/R	00	00	Off (Back Light)	42 4C 43
				01	01	On (Back Light)	
		CON	W/R	0~100	0~100	Contrast	43 4F 4E
HUE	W/R	0~100	0~100	Hue	48 55 45		

Main Item	Control Item	CMD	Type	Value (DEC)	Reply (DEC)	Content	CMD (HEX)
Display Adjustment	Display Adjustment	SAT	W/R	0~100	0~100	Saturation	53 41 54
		NOR	W/R	00	00	Noise Reduction: Off	4E 4F 52
				01	01	Noise Reduction: Low	
				02	02	Noise Reduction: Medium	
				03	03	Noise Reduction: High	
		MEM	W/R	00	00	MEMC: Off	4D 45 4D (AVF-6510 only)
				01	01	MEMC: Low	
				02	02	MEMC: Medium	
				03	03	MEMC: High	
		USR	W/R	0~100	0~100	Red Gain (mapping 0~100)	55 53 52
		USG	W/R	0~100	0~100	Green Gain (mapping 0~100)	55 53 47
		USB	W/R	0~100	0~100	Blue Gain (mapping 0~100)	55 53 42
		UOR	W/R	0~100	0~100	Red Offset (mapping 0~100)	55 4F 52
		UOG	W/R	0~100	0~100	Green Offset (mapping 0~100)	55 4F 47
		UOB	W/R	0~100	0~100	Blue Offset (mapping 0~100)	55 4F 42
	COT	W/R	00	00	User	43 4F 54	
			01	01	6500K		
			02	02	9300K		
			06	06	5000K		
			07	07	7500K		
	GAC	W/R	00	00	Gamma Off	47 41 43	
			01	01	Gamma 2.2		
VGA Adjustment	PHA	W/R	0~100	0~100	Phase	50 48 41	
	CLO	W/R	0~100	0~100	Clock	43 4C 4F	
	HOR	R/W	0~100	0~100	Horizontal Position	48 4F 52	
	VER	R/W	0~100	0~100	Vertical Position	56 45 52	
	ADJ	W	00	00	Auto Adjust	41 44 4A	
Sharpness	SHA	W/R	0~100	0~100	Sharpness	53 48 41	
Other Control	PIP Adjust	PSC	W/R	00	00	PIP OFF	50 53 43
				01	01	PIP Small	
				02	02	PIP medium	
				03	03	PIP large	
				04	04	PbP (Side By Side)	
				05	05	PbP Portrait	
				06	06	3 Windows	
				07	07	4 Windows	
	PIP Source Selection	PIN	W/R	00	00	VGA	50 49 4E
				09	09	HDMI 1	
				10	10	HDMI 2	
11				11	HDMI 3		



Main Item	Control Item	CMD	Type	Value (DEC)	Reply (DEC)	Content	CMD (HEX)
Other Control	PIP Source Selection	PIN	W/R	12	12	HDMI 4	50 49 4E
				13	13	DisplayPort	
				14	14	IPC/OPS	
				17	17	HDMI 5 (Front Panel)	
				18	18	Media Player (Win/Android)	
		PIO	W/R	(refer to PIN)	(refer to PIN)	Select the input source of sub window 2 (refer to PIN)	50 49 4F
		PIP	W/R	(refer to PIN)	(refer to PIN)	Select the input source of sub window 3 (refer to PIN)	50 49 50
	PIP position	PPO	W/R	00	00	PIP Position Bottom-left	50 50 4F
				01	01	PIP Position Bottom-Right	
				02	02	PIP Position Top-left	
				03	03	PIP Position Top-right	
	PIP/Main Swap	SWA	W	00	00	Swap main and PIP	53 57 41
	Scaling	ASP	W/R	00	00	Native	41 53 50
				01	01	Full Screen	
				02	02	Pillarbox/4:3	
				03	03	Letterbox	
		PAS	W/R	01	01	Full Screen	50 41 53
				02	02	Pillarbox/4:3	
				03	03	Letterbox	
		ZOM	W/R	0~10	0~10	Adjust overscan ratio	5A 4F 4D
		Baudrate Adjustment	BRA	W/R	00	00	115200
	01				01	38400	
	02				02	19200	
	03				03	9600	
	Other Control	RCU	W	00	00	MENU Key	52 43 55
				02	02	UP Key	
				03	03	DOWN Key	
04				04	LEFT Key		
05				05	RIGHT Key		
06				06	ENTER Key		
07				07	EXIT Key		
18				18	SOURCE Key		
23				23	SCALING Key		

Main Item	Control Item	CMD	Type	Value (DEC)	Reply (DEC)	Content	CMD (HEX)
Other Control	Other Control	RCU	W	24	24	FREEZE Key	52 43 55
				25	25	MUTE Key	
				28	28	AUTO Key	
				29	29	VOLUME+ Key	
				30	30	VOLUME- Key	
				43	43	Blank screen	
				44	44	MediaPlayer / Win10	
				160	160	Avocor LowBlue Bright- Key	
				161	161	Avocor LowBlue Bright+ Key	
		ALL	W	00	00	Reset all	41 4C 4C
		KLC	W/R	00	00	Un-lock keys	4B 4C 43
				01	01	Lock keys	
		SER	R		13 bytes	Read Serial Number	53 45 52
		MNA	R		13 bytes	Read Model Name	4D 4E 41
		GVE	R		6 bytes	Read Firmware Version	47 56 45
	RTV	R		Current value	Read RS232 table Version	52 54 56	
	GVS	W	00	[00]+5 byte	Querying main scaler version	47 56 53	
			01	[00]+5 byte	Querying sub mcu version		
			02	[00]+5 byte	Querying network module version		
	VOL	W/R	0~100	0~100	volume	56 4F 4C	
	BAS	W/R	0~12	0~12	Bass(-6~6)	42 41 53	
	TRE	W/R	0~12	0~12	Treble(-6~6)	54 52 45	
	BAL	W/R	0~12	0~12	Bass(-6~6)	42 41 4C	
	Audio	CAS	W/R	00	00	Current audio source: Analog	43 41 53
				01	01	Current audio source: HDMI1	
				02	02	Current audio source: HDMI2	
				03	03	Current audio source: HDMI3	
				04	04	Current audio source: HDMI4	
				05	05	Current audio source: Displayport1	
				07	07	Current audio source: OPS	
08				08	Current audio source: Front HDMI		
09				09	Current audio source: Win10		

Main Item	Control Item	CMD	Type	Value (DEC)	Reply (DEC)	Content	CMD (HEX)			
Other Control	Audio	INS	W/R	00	00	Internal Speaker Off	49 4E 53			
				01	01	Internal Speaker On				
		MUT	W/R	00	00	Mute Off	4D 55 54			
				01	01	Mute On				
	Scheme Selection	SCM	W/R	00	00	User	53 43 4D			
				01	01	Sport				
				02	02	Game				
				03	03	Cinema				
				04	04	Vivid				
	EcoMode	WFS	W/R	0	0	Set VGA_ONLY	57 46 53			
				1	1	Set VGA_DIGITAL_RS232				
				2	2	Set Never_Sleep				
	RTC	RTY	W/R	0~99	0~99	Set Real Time Year	52 54 59			
				RTM	W/R	1~12		1~12	Set Real Time Month	52 54 4D
				RTD	W/R	1~31		1~31	Set Real time Day	52 54 44
				RTH	W/R	0~23		0~23	Set Real Time Hour	52 54 48
				RTN	W/R	0~59		0~59	Set Real Time Minute	52 54 4E
		TMS	W/R	0	0	Same Settings On All	54 4D 53			
				1	1	Same Settings On Work Days				
				2	2	User				
		AEN	W/R	1	1	Sunday Alarm Enable	41 45 4E			
				2	2	Monday Alarm Enable				
				4	4	Tuesday Alarm Enable				
				8	8	Wednesday Alarm Enable				
				16	16	Thursday Alarm Enable				
				32	32	Friday Alarm Enable				
				64	64	Saturday Alarm Enable				
	AEF	W/R	1	1	Sunday Alarm Disable	41 45 46				
			2	2	Monday Alarm Disable					
			4	4	Tuesday Alarm Disable					

Main Item	Control Item	CMD	Type	Value (DEC)	Reply (DEC)	Content	CMD (HEX)
Other Control	RTC	AEF	W/R	8	8	Wednesday Alarm Disable	41 45 46
				16	16	Thursday Alarm Disable	
				32	32	Friday Alarm Disable	
				64	64	Saturday Alarm Disable	
		NNH	W/R	0~23	0~23	Monday On Hour	4E 4E 48
		NNM	W/R	0~59	0~59	Monday On Minute	4E 4E 4D
		NFH	W/R	0~23	0~23	Monday Off Hour	4E 46 48
		NFM	W/R	0~59	0~59	Monday Off Minute	4E 46 4D
		ENH	W/R	0~23	0~23	Tuesday On Hour	45 4E 48
		ENM	W/R	0~59	0~59	Tuesday On Minute	45 4E 4D
		EFH	W/R	0~23	0~23	Tuesday Off Hour	45 46 48
		EFM	W/R	0~59	0~59	Tuesday Off Minute	45 46 4D
		DNH	W/R	0~23	0~23	Wednesday On Hour	44 4E 48
		DNM	W/R	0~59	0~59	Wednesday On Minute	44 4E 4D
		DFH	W/R	0~23	0~23	Wednesday Off Hour	44 46 48
		DFM	W/R	0~59	0~59	Wednesday Off Minute	44 46 4D
		UNH	W/R	0~23	0~23	Thursday On Hour	55 4E 48
		UNM	W/R	0~59	0~59	Thursday On Minute	55 4E 4D
		UFH	W/R	0~23	0~23	Thursday Off Hour	55 46 48
		UFM	W/R	0~59	0~59	Thursday Off Minute	55 46 4D
		INH	W/R	0~23	0~23	Friday On Hour	INH
		INM	W/R	0~59	0~59	Friday On Minute	INM
		IFH	W/R	0~23	0~23	Friday Off Hour	IFH
		IFM	W/R	0~59	0~59	Friday Off Minute	IFM
		TNH	W/R	0~23	0~23	Saturday On Hour	TNH
		TNM	W/R	0~59	0~59	Saturday On Minute	TNM
		TFH	W/R	0~23	0~23	Saturday Off Hour	TFH
		TFM	W/R	0~59	0~59	Saturday Off Minute	TFM
		SNH	W/R	0~23	00~17	0~23	00~17
		SNM	W/R	0~59	00~3B	0~59	00~3B
		SFH	W/R	0~23	00~17	0~23	00~17
		SFM	W/R	0~59	00~3B	0~59	00~3B

Main Item	Control Item	CMD	Type	Value (DEC)	Reply (DEC)	Content	CMD (HEX)
Other Control	Auto Scan	ATS	W/R	0	0	Off	41 54 53
				1	1	Main	
				2	2	Multi	
				3	3	All	
	IRFM	IRF	W/R	0	0	Off	49 52 46
				1	1	On	
	Smart Light Control	SLC	W/R	0	0	Off	53 4C 43
				1	1	DCR	
				2	2	Light Sensor	
	Power LED	LED	W/R	0	0	Off	4C 45 44
				1	1	On	
	DisplayPort Mode	DPM	W/R	0	0	DP 1.1	44 50 4D
				1	1	DP 1.2	
	DisplayPort EDID	EDP	W/R	00	00	4Kx2K	45 44 50
				01	01	1080P	
	HDMI RGB Color Range	HCR	W/R	00	00	Auto Detect	48 43 52
				01	01	Full Range	
				02	02	Limited Range	
	Touch Control	TOC	W/R	00	00	Auto (Read Only)	54 4F 43
				01	01	OPS	
				02	02	External (Touch1 / Front USB)	
02				02	External Touch 2		
03				03	External touch 2 (Rear USB)		
04				04	Win10		
Win10 Player	Win10 Power Control	WPC	W/R	00	00	Read: 0 - Win PC Power is Off Read: 1 - Win PC Power is On Write: 0 - Release WinPC power button Write: 1- Press Win PC Power button untill receives release command Write: 2 - Press Win PC Power button for 1 second Write: 3 - Press Win PC Power button for 4 seconds Write: 4 - If Win PC is On, force shutdown Win PC (Press Win PC power button till WinPC is off).	57 50 43
				01	01		
				02	02		
				03	03		
				04	04		

Main Item	Control Item	CMD	Type	Value (DEC)	Reply (DEC)	Content	CMD (HEX)
OSD Control	Transpare-ncy	OST	W/R	0~4	0~4	OSD Transparency	4F 53 54
	H Position	OSH	W/R	0~100	0~100	OSD H Position	4F 53 48
	V Position	OSV	W/R	0~100	0~100	OSD V Position	4F 53 56
	OSD Language	OSL	W/R	00	00	English	4F 53 4C
				01	01	French	
				02	02	German	
				03	03	Dutch	
				04	04	Hungarian	
				05	05	Slovene	
				06	06	Serbian	
07				07	Croatian		
08				08	Danish		
OSD Timeout	OSO	W/R	5~60	5~60	OSD Timeout (5, 10, 20, 30, 60 sec)	4F 53 4F	
Splash Screen	SPS	W/R	0	0	Off	53 50 53	
			1	1	On		
Ethernet Setup	Network Enable	NWE	W/R	0	0	No	4E 57 45
				1	1	Yes	
	Dynamic IP	DIP	W/R	0	0	Disable	44 49 50
				1	1	Enable	
	Default	LDS	W	0	0	Load network default settings (It will take about 15 seconds.)	4C 44 53
	E-Mail Alert	PSA	W/R	0	0	Off (Power Status Alert)	50 53 41
				1	1	On (Power Status Alert)	
		SSA	W/R	0	0	Off (Source Status Alert)	53 53 41
				1	1	On (Source Status Alert)	
		SLA	W/R	0	0	Off (Signal Lost Alert)	53 4C 41
				1	1	On (Signal Lost Alert)	
	Static IP Settings	IP1	W/R	0~255	0~255	Static IP Address 1	49 50 31
		IP2	W/R	0~255	0~255	Static IP Address 2	49 50 32
		IP3	W/R	0~255	0~255	Static IP Address 3	49 50 33
		IP4	W/R	0~255	0~255	Static IP Address 4	49 50 34
		MK1	W/R	0~255	0~255	Subnet Mask 1	4D 4B 31
MK2		W/R	0~255	0~255	Subnet Mask 2	4D 4B 32	
MK3		W/R	0~255	0~255	Subnet Mask 3	4D 4B 33	
MK4		W/R	0~255	0~255	Subnet Mask 4	4D 4B 34	
GW1		W/R	0~255	0~255	Gateway 1	47 57 31	

Main Item	Control Item	CMD	Type	Value (DEC)	Reply (DEC)	Content	CMD (HEX)
Ethernet Setup	Static IP Settings	GW2	W/R	0~255	0~255	Gateway 2	47 57 32
		GW3	W/R	0~255	0~255	Gateway 3	47 57 33
		GW4	W/R	0~255	0~255	Gateway 4	47 57 34
		FD1	W/R	0~255	0~255	DNS Address 1	46 44 31
		FD2	W/R	0~255	0~255	DNS Address 2	46 44 32
		FD3	W/R	0~255	0~255	DNS Address 3	46 44 33
		FD4	W/R	0~255	0~255	DNS Address 4	46 44 34
		SNS	W	0	0	Save Network Settings	53 4E 53
		MAC	W	0~5	0~255	Querying MAC ID #0~#5	4D 41 43

## Using Discrete IR Codes

The display accepts commands in the form of infrared (IR) signals that conform to the NEC protocol. Each display remote control button has an IR control code associated with it.

You can use these codes to program a third-party, "universal" remote control unit to work with the display. These third-party products usually come with a computer software application for this purpose. For more information, consult the documentation provided with the remote control unit.

### IR Command Protocol

The IR control codes have the following characteristics:

- Each code consists of the following:
  - A leader pulse (a modulated pulse of 9 ms followed by a non-modulated pulse of 4.5 ms);
  - 16 address bits (also called a "custom code"): eight (8) bits for the address followed by the logical inverse of the address. The custom code for the display is 16559 decimal (0x40AF, binary 01000000 10101111);
  - 16 data bits: eight (8) bits for the command followed by the logical inverse of the command;
  - An end pulse (a modulated pulse of 0.56 ms, similar to the modulated pulse in the '0' and '1' bits). The end of the modulated pulse constitutes the end of the data transmission.
- The carrier frequency is 38 kHz, with the modulated pulses having a 33% duty cycle.
- Commands are sent at a maximum rate of 9 Hz.

For example, here is the NEC control code for the POWER button on the display remote control unit:

Hex	40	AF	1C	E3
Binary	01000000	10101111	00011100	11100011
Function	Cust. Code Byte 1	Cust. Code Byte 2	Command	Command (Logical Inverse)



## IR Control Code List

Table 6-3 lists the IR control codes for the display.

**Table 6-3. Infrared (IR) Control Codes**

NO	Customer Code	Data Code	Function
1	40AF	04FB	-----
2	40AF	1CE3	POWER
3	40AF	07F8	SOURCE
4	40AF	08F7	-----
5	40AF	09F6	WIN PC
6	40AF	0AF5	BLANK
7	40AF	0BF4	-----
8	40AF	0CF3	FREEZE
9	40AF	1AE5	-----
10	40AF	15EA	MUTE
11	40AF	10EF	-----
12	40AF	11EE	VOLUME -
13	40AF	0DF2	-----
14	40AF	16E9	VOLUME +
15	40AF	06F9	BRIGHTNESS SETTINGS -
16	40AF	13EC	BRIGHTNESS SETTINGS +
17	40AF	02FD	UP
18	40AF	01FE	LEFT
19	40AF	0EF1	MENU
20	40AF	03FC	RIGHT
21	40AF	19E6	DOWN
22	40AF	12ED	ENTER
23	40AF	05FA	EXIT
24	40AF	40BF	-----
25	40AF	41BE	-----
26	40AF	14EB	AUTO
27	40AF	43BC	-----
28	40AF	00FF	SCALING
29	40AF	17E8	-----
30	40AF	18E7	-----
31	40AF	1EE1	-----
32	40AF	0FF0	-----
33	40AF	1BE4	-----
34	40AF	1DE2	-----
35	40AF	1FE0	-----
36	40AF	42BD	-----

Notes:

# 7. Specifications

Table 7-1 lists the signal types supported by each input on the display.

<b>AVF-7510</b>	
<b>PANEL</b>	
Diagonal Size (Inch)	75"
Backlight	Edge LED
Aspect Ratio	16:9
Input Resolution	3840 x 2160 @ 60 Hz
Response Time	8 (ms)
Brightness	410 (cd/m <sup>2</sup> )
Contrast Ratio	1200:1
Viewing Angle	178° (H) / 178° (V)
Supported Colours	1.07 Billion colours
Display Orientation	Landscape compatible
<b>TOUCH SYSTEM</b>	
Interface	Touch USB
Touch	High-resolution inGlass™ touch; Up to 10 points
Glass	AGC glass; 0.1-inch thickness
Supported Operating System	Windows 7 / 8 / 10; Mac OS 10
<b>AUDIO</b>	
Built-in Speakers	4 KΩ / 2 x 10W
<b>CONNECTIVITY</b>	
Connections	5 x HDMI / 1 x VGA / 1 x DisplayPort
Audio	Audio Out / PC Audio In / SPDIF Out
Control	2 x Touch USB / RS232 / Ethernet
<b>WIN PC <small>Note</small></b>	
CPU	Intel Atom Quad Core Processor
Memory	2GB DDR3
Storage	32GB (eMMC)
Ethernet	10/100 Mbps (RJ-45)
WiFi	802.11 b/g/n, 2.4GHz, 1T1R, Realtek RTL8723BS Module
Bluetooth	4.0
USB 2.0/3.0	x2 / x1 (Type A)
OS	Windows 10 Home Edition (x64)
<b>PHYSICAL SPECIFICATIONS</b>	
Dimensions	67.7 x 41.2 x 3.7 (in)
Weight	Net: 87 kg / Gross: 95 kg
Wall Mount (VESA)	23.6 x 15.7 (in) 23.6 x 23.6 (in)
Fanless Design	Yes

<b>OSD FUNCTIONS</b>	
<b>OSD Languages</b>	English, German, Dutch, French, Danish, Slovenian, Hungarian, Serbian, Croatian
<b>Source Auto Detect Function</b>	Yes
<b>POWER</b>	
<b>Power Supply</b>	AC100-240V (Worldwide), Max 3.5 A, 50/60Hz
<b>Maximum Power Consumption</b>	320 W
<b>Standby</b>	≤0.5 W
<b>ENVIRONMENTAL</b>	
<b>Operating Temperature</b>	5 °C ~ 40 °C
<b>Storage Temperature</b>	-20 °C ~ 60 °C
<b>Humidity</b>	35% ~ 85%



**NOTE**

*When the display is powered up for the first time, turning on the WIN PC will take 12-20 seconds to initiate.*

## Supported Timings

Table 7-2 lists the signal types supported by each input on the display.

**Table 7-2. Supported Timings By Input**

Timing		fH (kHz)	fV (Hz)	Dot clock (MHz)	HDMI	VGA	DisplayPort	
VESA	VGA 640x480	31.469	59.94	25.175	○	○	○	
		37.861	72.809	31.5	○	○	○	
		37.5	75	31.5	○	○	○	
		43.269	85.008	36	○	○	○	
	SVGA 800x600	35.156	56.25	36	○	○	○	
		37.879	60.317	40	○	○	○	
		48.077	72.188	50	○	○	○	
		46.875	75	49.5	○	○	○	
	XGA 1024x768	53.674	85.06	56.25	○	○	○	
		48.363	60.004	65	○	○	○	
		56.476	70.069	75	○	○	○	
		60.023	75.029	78.75	○	○	○	
	WXGA1366x768	68.677	84.997	94.5	○	○	○	
		47.712	59.79	85.5	○	○	○	
		1280 x 720	44.444	59.98	64	-	○	○
	44.772		59.86	74.5	-	○	○	
	56.456		74.78	95.75	-	○	○	
	1280 x 768	47.776	59.87	79.5	-	○	○	
		47.396	59.995	68.25	-	○	○	
		68.633	84.837	117.5	-	○	○	
	1280 x 800	49.306	59.91	71	○	○	○	
		49.702	59.81	83	○	○	○	
	SXGA	1152x864	67.5	75	108	○	○	○
		1280x1024	63.981	60.02	108	○	○	○
			79.976	75.025	135	○	○	○
	1440 x 900	91.146	85.024	157.5	-	○	○	
		55.469	59.901	88.75	-	-	○	
	WSXGA+ 1680 x1050	55.935	59.88	106.5	○	○	○	
		64.674	59.883	119	○	○	○	
	UXGA 1600 x 1200	65.29	59.954	146.25	○	○	○	
75		60	162	○	○	○		
1920 x 1080	66.587	59.93	138.5	-	○	○		
WUXA 1920 x 1200	74.038	59.95	154	-	○	○		
QHD 2560x1440	88.787	59.951	241.5	○	-	○		
	89.521	59.961	312.25	-	-	○		
QSXGA 2560x1600	98.713	59.972	268.5	○	-	○		
	99.458	59.987	348.5	-	-	○		
EDTV	480p	31.5	60	27.03	○	-	○	
	576p	31.25	50	27	○	-	○	
HDTV	720p	37.5	50	74.25	○	-	○	
	1280x720	44.995	59.94	74.176	○	-	○	
		45	60	74.25	○	-	○	

Timing		fH (kHz)	fV (Hz)	Dot clock (MHz)	HDMI	VGA	DisplayPort	
	1080i	28.13	50	74.25	○	-	○	
	1920x1080	33.716	59.94	74.176	○	-	○	
		33.75	60	74.25	○	-	○	
	1080p 1920x1080		27	24	74.25	○	-	○
			28.125	25	74.25	○	-	○
			33.75	30	74.25	○	-	○
			56.25	50	148.5	○	-	○
			67.433	59.94	148.352	○	-	○
	67.5	60	148.5	○	○	○		
4K2K	3840x2160	54	24	297	○	-	○	
		56.25	25	297	○	-	○	
		67.5	30	297	○	-	○	
		110.5	49.977	442	-	-	○	
		112.5	50	594	-	-	○	
		133.313	59.997	533.25	-	-	○	
		135	60	594	-	-	○	

# Overall Dimensions

Figure 7-1 shows the display dimensions of AVF-7510 (all dimensions are in inches).

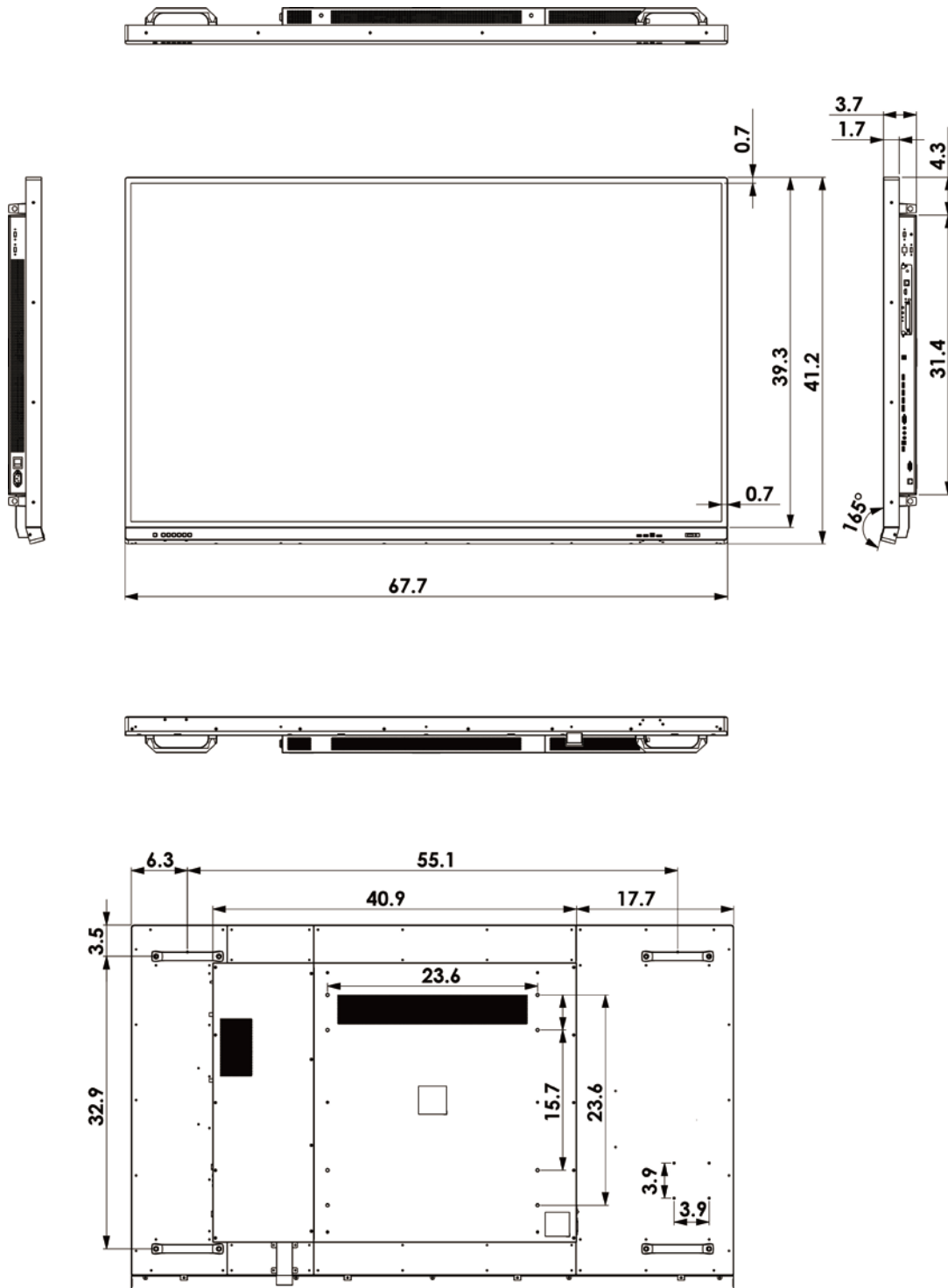

Figure 7-1. AVF-7510 Display Dimensions

Notes:



# Appendix I: Moving and Carrying Notice

## Moving the Display:

Moving the display requires at least two people. Attempting to move the display with one person may result in dropping the display and/or serious injury. When moving a display in its shipping carton, lift the carton using the white handles.

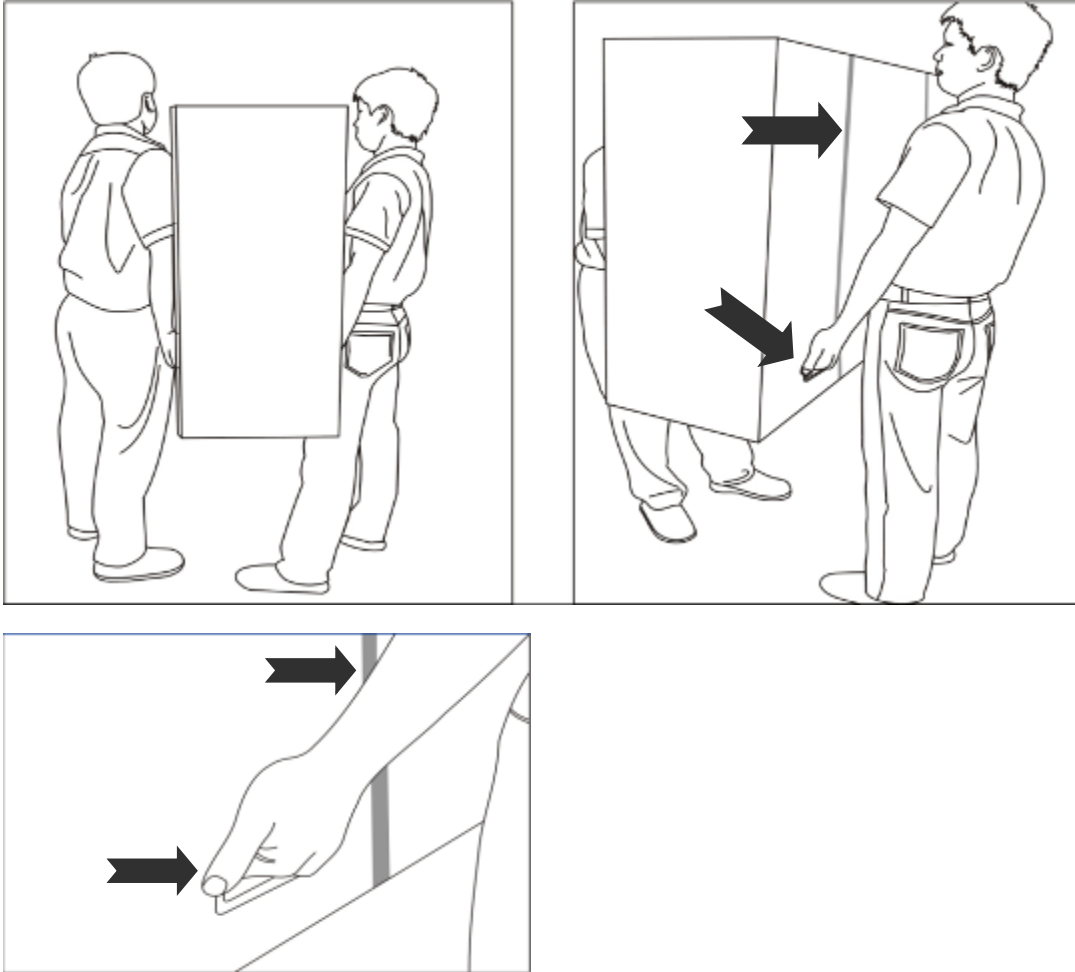

## Carrying the display:

This display is heavy; please follow proper lifting technique, as pictured below. Failure to do so may cause injury.



# Appendix II: Installing a Wall Mount

Before installing, please make sure the wall is strong enough to hold the necessary weight of the display and the mount.

**Step1.** Keep the display facing the ground and place it on a flat object.

**Step2.** Remove the screws (M8\*15) from the back of the display.

**Step3.** Align the wall brackets with the mounting holes and attach the brackets to the display using the screws removed in Step 2.

**Caution:** Longer screws will damage the display.

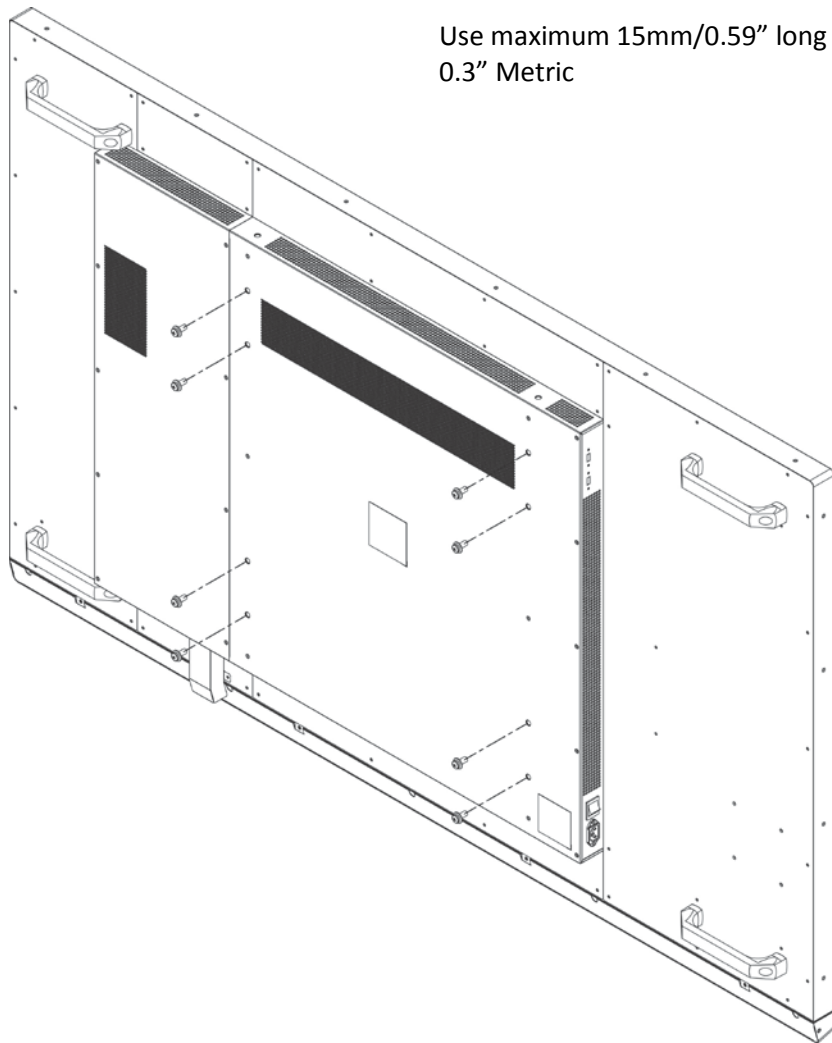

Use maximum 15mm/0.59" long screws.  
0.3" Metric

# Appendix III: Installing an OPS Module

Follow the steps below to install an OPS module.

**Step1.** Use a screw driver to unscrew the OPS slot cover on the display input panel.  
Do not lose the screws that are removed.

**Step2.** Install the OPS module by sliding it into the .OPS slot until you hear a click, indicating the module is securely inserted.

**Step3.** Secure the OPS module in position by screwing it onto the display input panel using the screws that are removed earlier.

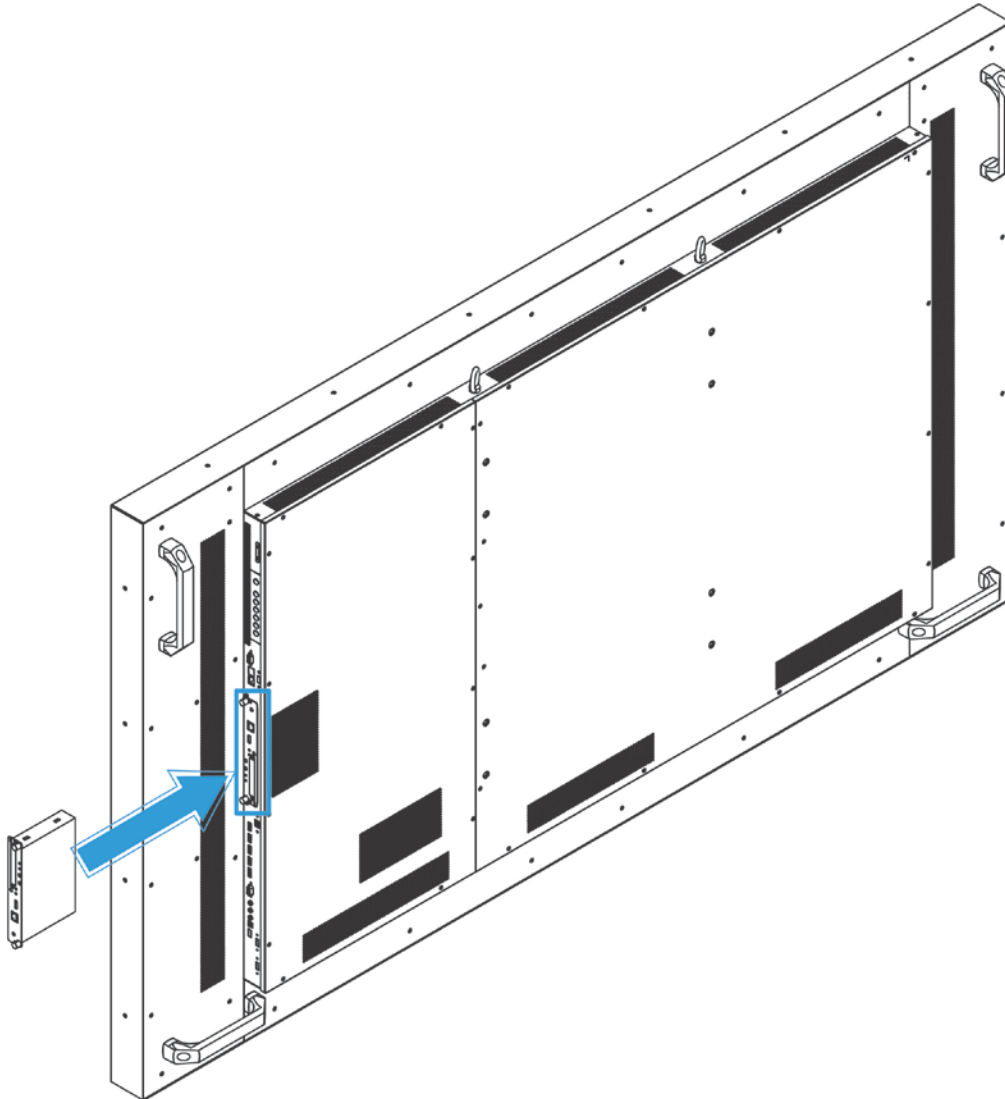

# Appendix IV: Wall Mount Safety Notes

1. Please make sure if the bracket is fixed to the solid wall / solid pillar for fear of falling due to heavy weight.

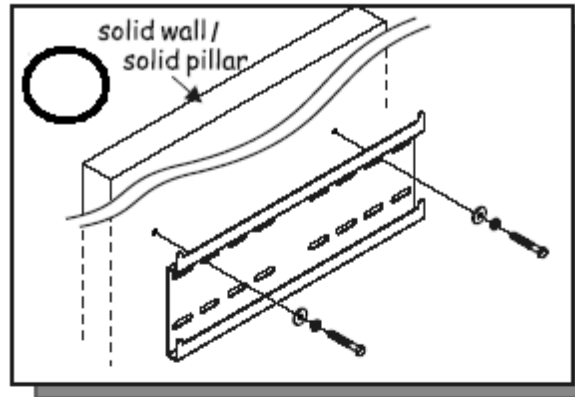
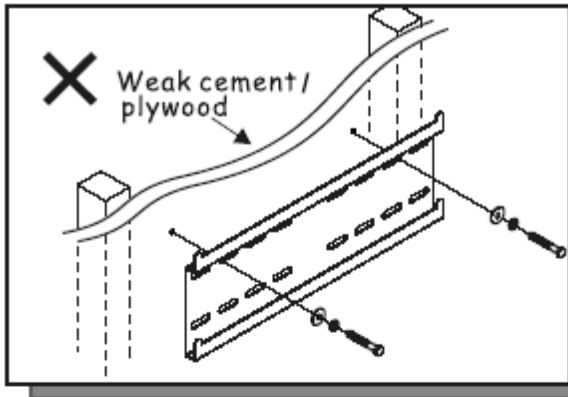

2. After assembling, please don't pull or shake violently.

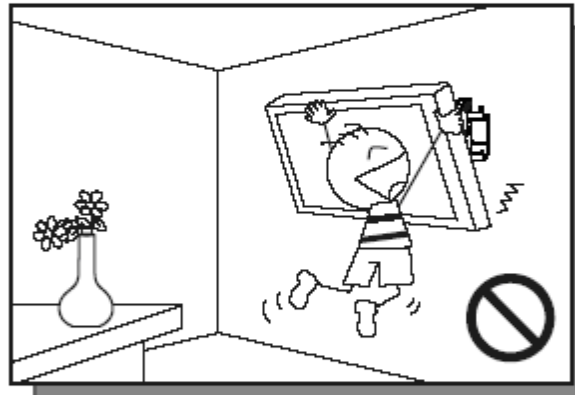
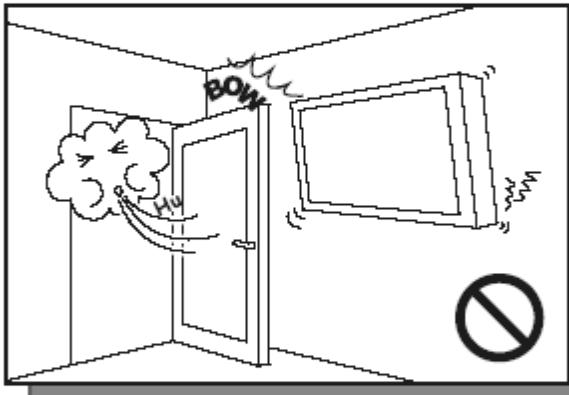

3. Please don't install the bracket directly under the sunshine or humidity / high temperature places for fear that the quality is effected.

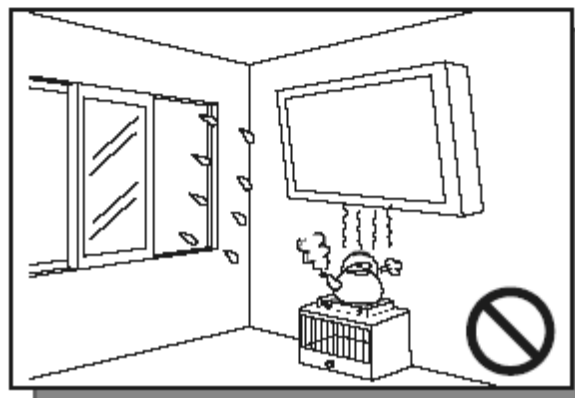
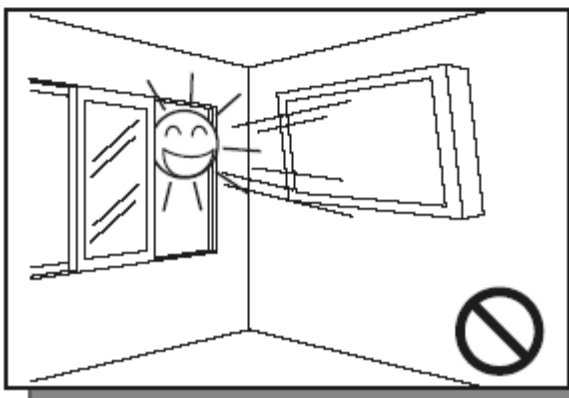

**4.**

Installing the bracket over 10 cm from each wall side and being vertical to the ground is the suggested installing position.

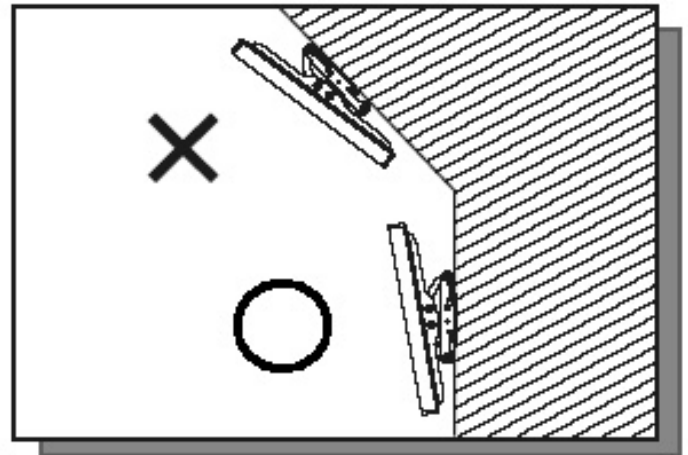
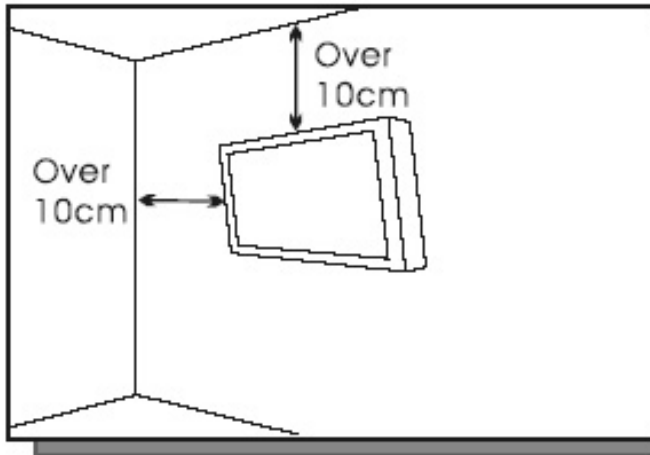

**5.**

Please make sure to hang on the mounting hooks firmly.

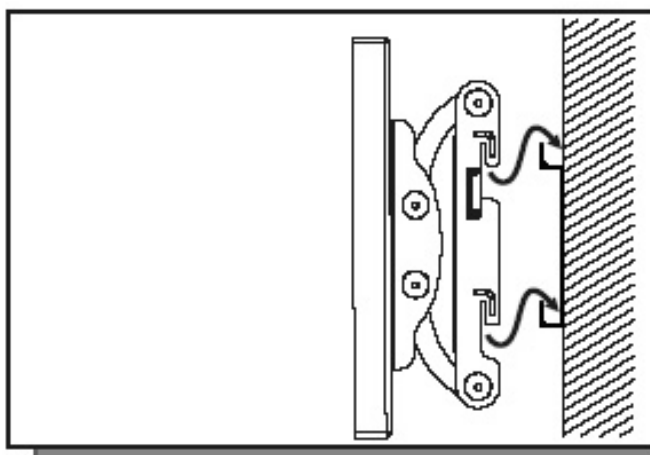

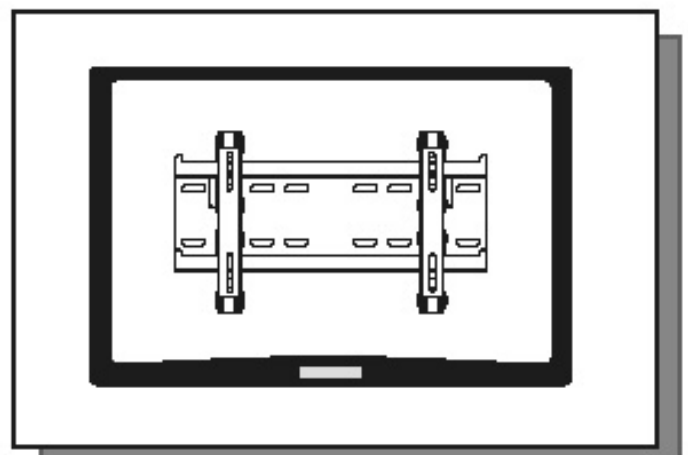

**6.**

The flat screen must be put in the mid of the bracket for fear of slope.



# Appendix V: Power/ PC Key Operations

	When current input is WIN PC:	When current input is NOT WIN PC:
	<ul style="list-style-type: none"> <li>When Win10 PC Power Mode is set to Auto or Manual, pressing the button once will turn on Win10 PC.</li> <li>When Win10 PC is on, pressing the button once will turn off Win10 PC.</li> <li>When Win10 PC Power Mode is set to Off and Win10 PC is turned Off, pressing the button once will switch the input source to OPS.</li> </ul>	<ul style="list-style-type: none"> <li>When Win10 PC Power Mode is set to Auto or Manual, pressing the button once will switch the input source to Win10 PC and turn on Win10 PC.</li> <li>When Win10 PC Power Mode is set to Off and Win10 PC is turned off, pressing the button once will switch the input source to OPS.</li> </ul>
	<ul style="list-style-type: none"> <li>Press the button to turn on/off the display.</li> <li>When Win10 PC Power Mode is set to Auto, pressing the button will turn on the display and Win10 PC.</li> <li>When Win10 PC is running and Win10 PC Power Mode is set to Auto or Manual, pressing the button will turn off the screen and Win10 PC will remain running in the background.</li> </ul>	



## NOTE

1. Operation of the power/PC keys will not conform to the description above if you have made changes to the default Power/Sleep settings in the windows PC.
2. Please avoid unplugging the AC power cord while Win10 PC is still on. To check the status of Win10 PC, you may check the floating message box on screen, or use the remote control to enter the OSD menu and find the information in the Information menu page.

# Appendix VI: Ethernet Remote Control Settings

The device can be configured by opening a browser and connecting to web server directly.

Use the browser to configure the demo board. Connect the browser to the IP address of NET2UART module, and the Login window will pop up as follows.

**USER LOG IN**

Site:	10.200.6.78
ID:	<input style="width: 80%;" type="text"/>
Password:	<input style="width: 80%;" type="password"/>
<input type="button" value="OK"/>	

Default IP	192.168.2.1
Default ID	admin
Default Password	system

## Configurations

### Administrator

#### Authentication Configuration

##### Administrator

[Authentication Configuration](#)

[System IP Configuration](#)

[Network Status](#)

[Display Status](#)

[Load default setting](#)

[Firmware update](#)

[Boot Loader upgrade](#)

##### TCP Mode

##### UDP Mode

##### UART

##### SMTP

##### Reset Device

##### Logout

#### Authentication Configuration

Setting	Value
Username	<input style="width: 80%;" type="text" value="admin"/> max:15
Password	<input style="width: 80%;" type="password" value="•••••"/> max:15
Confirm	<input style="width: 80%;" type="password" value="•••••"/>
<input type="button" value="Update"/>	
Please refresh web page after press "updated" button.	

Note:

Comment name only can use "0-9", "a-z", "A-Z"

## System IP Configuration

### Administrator

[Authentication Configuration](#)

[System IP Configuration](#)

[Network Status](#)

[Display Status](#)

[Load default setting](#)

[Firmware update](#)

[Boot Loader upgrade](#)

[TCP Mode](#)

[UDP Mode](#)

[UART](#)

[SMTP](#)

[Reset Device](#)

[Logout](#)

## System IP Configuration

Setting	Value
IP Address	<input type="text" value="192"/> . <input type="text" value="168"/> . <input type="text" value="2"/> . <input type="text" value="1"/>
Subnet Mask	<input type="text" value="255"/> . <input type="text" value="255"/> . <input type="text" value="255"/> . <input type="text" value="0"/>
Gateway	<input type="text" value="192"/> . <input type="text" value="168"/> . <input type="text" value="2"/> . <input type="text" value="1"/>
DNS	<input type="text" value="192"/> . <input type="text" value="168"/> . <input type="text" value="2"/> . <input type="text" value="1"/>
IP Configure	<input type="radio"/> Static <input checked="" type="radio"/> DHCP
VLAN Tag	<input checked="" type="radio"/> Disable <input type="radio"/> Enable : VLAN ID <input type="text" value="0"/>

Please refresh web page after press "updated" button.

## Network Status

### Administrator

[Authentication Configuration](#)

[System IP Configuration](#)

[Network Status](#)

[Display Status](#)

[Load default setting](#)

[Firmware update](#)

[Boot Loader upgrade](#)

[TCP Mode](#)

[UDP Mode](#)

[UART](#)

[SMTP](#)

[Reset Device](#)

[Logout](#)

## Network Status

Kernel Version	V3021 (Feb 17 2014 14:42:18)
MAC Address	00:1F:B6:00:01:DB
Nickname	<input type="text" value="NetUART"/> <input type="button" value="Update"/> Please refresh web page after press "updated" button.

Note:

Comment name only can use "0-9","a-z","A-Z","\_","-"

## Load Default Setting

### Administrator

[Authentication Configuration](#)

[System IP Configuration](#)

[Network Status](#)

[Display Status](#)

[Load default setting](#)

[Firmware update](#)

[Boot Loader upgrade](#)

[TCP Mode](#)

[UDP Mode](#)

[UART](#)

[SMTP](#)

[Reset Device](#)

[Logout](#)

Load Default Setting to EEPROM



## Firmware Update

### Administrator

- [Authentication Configuration](#)
- [System IP Configuration](#)
- [Network Status](#)
- [Display Status](#)
- [Load default setting](#)
- [Firmware update](#)
- [Boot Loader upgrade](#)

### TCP Mode

### UDP Mode

### UART

### SMTP

### Reset Device

### Logout

### Firmware update

Load

## Boot Loader Upgrade

### Administrator

- [Authentication Configuration](#)
- [System IP Configuration](#)
- [Network Status](#)
- [Display Status](#)
- [Load default setting](#)
- [Firmware update](#)
- [Boot Loader upgrade](#)

### TCP Mode

### UDP Mode

### UART

### SMTP

### Reset Device

### Logout

### Upgrade the Boot Loader

Load

## TCP Mode

### Administrator

[Authentication Configuration](#)

[System IP Configuration](#)

[Network Status](#)

[Display Status](#)

[Load default setting](#)

[Firmware update](#)

[Boot Loader upgrade](#)

**TCP Mode**

**UDP Mode**

**UART**

**SMTP**

**Reset Device**

**Logout**

## TCP Control

Item	Value
Telnet Server/Client	<input checked="" type="radio"/> Server <input type="radio"/> Client <input type="radio"/> Disable
Data Port Number	<input type="text" value="23"/>
Remote Server IP Address	<input checked="" type="radio"/> IP <input type="text" value="210"/> <input type="text" value="200"/> <input type="text" value="181"/> <input type="text" value="102"/> <input type="radio"/> Domain Name <input type="text" value="0"/>
Client mode inactive timeout	<input type="text" value="20"/> minute (1~99,0=Disable)
Server mode protect timeout	<input type="text" value="60"/> minute (1~98,0=Disable,99=Can't replace)
<input type="button" value="Update"/> Please refresh web page after press "updated" button.	

### Telnet Server/Client

Set the device to be a Telnet Server or Client.

### Port Number

When in Server mode, assign the port number used to connect remotely. When in Client mode, assign the port number for the device to connect to the remote site.

### Remote Server IP Address

When in Client mode, the device will connect to the remote server with the IP address set here.

### Client mode inactive timeout

When NET2UAR is operating in TCP client mode, it will always try to connect with the remote server. The time configured here is for NET2UART to rebuild connection after timeout.

### Server mode protect timeout

When NET2UART is operating in TCP server mode, it would protect the TCP connection from getting replaced in the period of the time set here.

# UDP Mode

## Administrator

[Authentication Configuration](#)

[System IP Configuration](#)

[Network Status](#)

[Display Status](#)

[Load default setting](#)

[Firmware update](#)

[Boot Loader upgrade](#)

[TCP Mode](#)

**UDP Mode**

[UART](#)

[SMTP](#)

[Reset Device](#)

[Logout](#)

## UDP

Item	Value	
Mode	<input type="radio"/> Listen <input type="radio"/> Normal <input checked="" type="radio"/> Disable	
Local Port	21	
Remote Address	IP	Port
	<input checked="" type="radio"/> 0 . 0 . 0 . 0 IP <input type="radio"/> Domain Name	0
	<input checked="" type="radio"/> 0 . 0 . 0 . 0 IP <input type="radio"/> Domain Name	0
	<input checked="" type="radio"/> 0 . 0 . 0 . 0 IP <input type="radio"/> Domain Name	0
	<input checked="" type="radio"/> 0 . 0 . 0 . 0 IP <input type="radio"/> Domain Name	0
	<input checked="" type="radio"/> 0 . 0 . 0 . 0 IP <input type="radio"/> Domain Name	0
	<input checked="" type="radio"/> 0 . 0 . 0 . 0 IP <input type="radio"/> Domain Name	0
	<input checked="" type="radio"/> 0 . 0 . 0 . 0 IP <input type="radio"/> Domain Name	0
	<input checked="" type="radio"/> 0 . 0 . 0 . 0 IP <input type="radio"/> Domain Name	0
	<input checked="" type="radio"/> 0 . 0 . 0 . 0 IP <input type="radio"/> Domain Name	0
<input type="button" value="Update"/>		
Please refresh web page after press "updated" button.		

## Status

When TCP mode is set as Server mode or Client mode, the UDP mode would be disabled automatically, and vice versa.

## Local Port

Assign the port number here to allow the device to open for the remote site to send data via UDP. The IP address of the remote site must be set in the Remote Address table, or NET2UART will ignore its data.

## Remote Address

The Remote Address table allows 10 entries of remote site IP addresses and ports. When NET2UART is sending data to network, the data will be sent to the each remote IP address entered in the table simultaneously. The port number is the remote site port number that NET2UART will send data to via UDP.

If the port number is set as "0", the NET2UART will use the port number that the remote site sends data from as the destination port number, or use the local port number as the destination port number if the remote site has not sent data to NET2UART.

## UART

### Administrator

[Authentication](#)

[Configuration](#)

[System IP](#)

[Configuration](#)

[Network Status](#)

[Display Status](#)

[Load default setting](#)

[Firmware update](#)

[Boot Loader upgrade](#)

[TCP Mode](#)

[UDP Mode](#)

[UART](#)

[SMTP](#)

[Reset Device](#)

[Logout](#)

## UART Control

Item	Setting
Mode	RS232
Baudrate	115200
Character Bits	8
Parity Type	none
Stop Bit	1
Hardware Flow Control	none
Uart Memory Overflow count	0M,0K,0Byte
Uart FIFO Overflow count	0times
Delimiter	<input type="checkbox"/> Character 1: 00, <input type="checkbox"/> Character 2: FF <input type="checkbox"/> Silent time: 5 (1~255)*200ms <input type="checkbox"/> Drop Character
<input type="button" value="Update"/> Please refresh web page after press "updated" button.	

### Mode

Select the UART interface.

### Baud rate

Select the baud rate of UART interface.

### Character Bits

Select the number of character bits of UART interface.

### Parity Type

Select the parity type of UART interface.

### Stop Bit

Select the stop bit type of UART interface.

### Hardware Flow Control

Select the flow control type of UART interface. The hardware flow control will use CTS/RTS for the control signals.

### Uart Memory Overflow count

Shows the number of overflow bytes in network buffer.

### Uart FIFO Overflow count

Shows the number of overflow times in UART RX buffer.

## Delimiter

- Character 1 & 2:

Set Character 1 and/or Character 2 to be the delimiter.

Once the delimiter is active, NET2UART would monitor all data received from UART. All data received from UART will be stored in NET2UART internal buffer first, and will only be sent to Ethernet once the delimiter is detected. If the delimiters have not been detected and the internal buffer of NET2UART is stuffed, the incoming data will overwrite the previous data stored in NET2UART.

- Drop Character:

The Drop Character is set to drop delimiter or not. If Drop Character is active, the delimiter received from UART will not be sent out to Ethernet.

- Silent time:

Once the Silent time is active, NET2UART will keep all data received from UART in its internal buffer and check the time period of no data received from UART. It will then send out the internal data once the time is out.

## SMTP

### Administrator

[Authentication](#)

[Configuration](#)

[System IP](#)

[Configuration](#)

[Network Status](#)

[Display Status](#)

[Load default setting](#)

[Firmware update](#)

[Boot Loader upgrade](#)

[TCP Mode](#)

[UDP Mode](#)

[UART](#)

[SMTP](#)

[Reset Device](#)

[Logout](#)

### SMTP setup

Enable SMTP	<input type="checkbox"/> Enable,Port: 25
SMTP server address	smtp.xxx.yyy
SMTP Login Information	<input type="checkbox"/> Enable Username: username, Password: ●●●●●●
Mail to	xxx@yyy.zzz max: 200
Mail from	xxx@yyy.zzz
SMTP 01 Warning	
Subject	Power Status Change Alert
Message Body	SMTP 01 body max: 100
SMTP 02 Warning	
Subject	Source Change Alert
Message Body	SMTP 02 body max: 100
SMTP 03 Warning	
Subject	Signal Lost Alert
Message Body	SMTP 03 body max: 100

## Reset Device

Reset NET2UART module.

Administrator

[TCP Mode](#)

[UDP Mode](#)

[UART](#)

[SMTP](#)

[Reset Device](#)

[Logout](#)

Reset Device

Reset