

vivitek[®]
Vivid Color, Vivid Life

User's Manual
用戶手冊

D75 Series

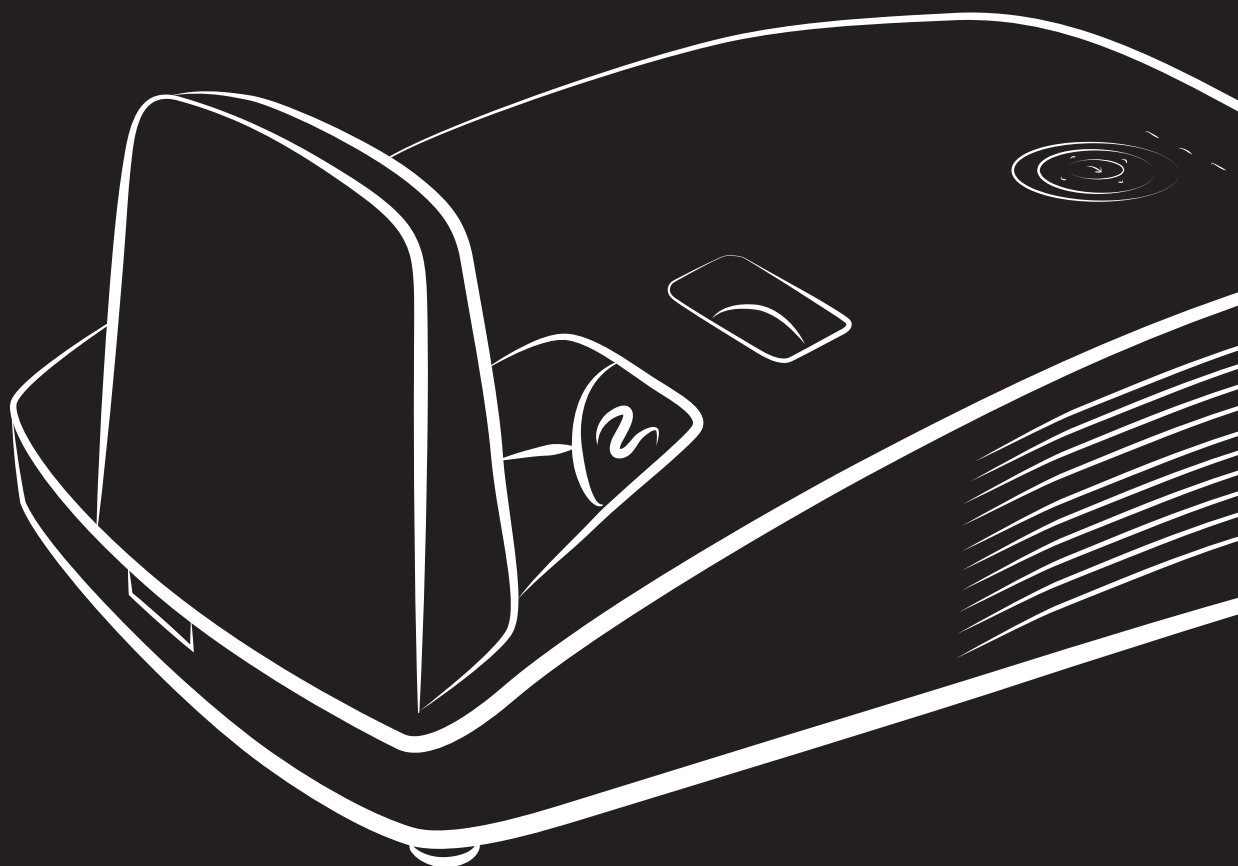

PICTURE BY
DLP[®]
TEXAS INSTRUMENTS

Copyright

This publication, including all photographs, illustrations and software, is protected under international copyright laws, with all rights reserved. Neither this manual, nor any of the material contained herein, may be reproduced without written consent of the author.

© Copyright 2014

Disclaimer

The information in this document is subject to change without notice. The manufacturer makes no representations or warranties with respect to the contents hereof and specifically disclaims any implied warranties of merchantability or fitness for any particular purpose. The manufacturer reserves the right to revise this publication and to make changes from time to time in the content hereof without obligation of the manufacturer to notify any person of such revision or changes.

Trademark Recognition



Kensington is a U.S. registered trademark of ACCO Brand Corporation with issued registrations and pending applications in other countries throughout the world.



HDMI, the HDMI Logo, and High-Definition Multimedia Interface are trademarks or registered trademarks of HDMI Licensing LLC in the United States and other countries.

All other product names used in this manual are the properties of their respective owners and are acknowledged.

Important Safety Information



Important:

*It is strongly recommended that you read this section carefully before using the projector. These safety and usage instructions will ensure that you enjoy many years of safe use of the projector. **Keep this manual for future reference.***

Symbols Used

Warning symbols are used on the unit and in this manual to alert you of hazardous situations. The following styles are used in this manual to alert you to important information.

Note:

Provides additional information on the topic at hand.



Important:

Provides additional information that should not be overlooked.



Caution:

Alerts you to situations that may damage the unit.



Warning:

Alerts you to situations that may damage the unit, create a hazardous environment, or cause personal injury.

Throughout this manual, component parts and items in the OSD menus are denoted in bold font as in this example:

“Push the **Menu** button on the remote control to open the **Main** menu.”

General Safety Information

- Do not open the unit case. Aside from the projection lamp, there are no user-serviceable parts in the unit. For servicing, contact qualified service personnel.
- Follow all warnings and cautions in this manual and on the unit case.
- The projection lamp is extremely bright by design. To avoid damage to eyes, do not look into the lens when the lamp is on.
- Do not place the unit on an unstable surface, cart, or stand.
- Avoid using the system near water, in direct sunlight, or near a heating device.
- Do not place heavy objects such as books or bags on the unit.

Note:

RG1 IEC 62471-5:2015

Projector Installation Notice

- Place the projector in a horizontal position
The tilt angle of the projector should not exceed 15 degrees, nor should the projector be installed in any way other than the desktop and ceiling mount, otherwise lamp life could decrease dramatically, and may lead to other **unpredictable damages**.
- Allow at least 50 cm clearance around the exhaust vent.
- Ensure that the intake vents do not recycle hot air from the exhaust vent.
- When operating the projector in an enclosed space, ensure that the surrounding air temperature within the enclosure does not exceed operation temperature while the projector is running, and the air intake and exhaust vents are unobstructed.
- All enclosures should pass a certified thermal evaluation to ensure that the projector does not recycle exhaust air, as this may cause the device to shutdown even if the enclosure temperature is within the acceptable operation temperature range.

Verify Installation Location

- To supply power, the 3-blade (with earthing lead) socket should be used to ensure proper grounding and equalized ground potential for all of the equipment in the Projector System.
- The power code provided with the Projector should be used. In case of any missing item, other qualified 3-blade (with earthing lead) power cord can be used as substitution; however, do not use 2-blade power cord.
- Verify if the voltage is stable, grounded properly and there is no electricity leakage.
- Measure total power consumption which should not higher the safety capacity and avoid safety issue and short circuit.
- Turn on Altitude Mode when located in high altitude areas
- The projector can only be installed upright or inverted.
- When installation the bracket, make sure the weight limit is not exceed and firmly secured.
- Avoid installing near air conditioner duct or subwoofer.
- Avoid installing at high temperature, insufficient cooling and heavy dust locations.
- Keep your product away from fluorescent lamps to avoid malfunction caused by IR interference.
- The VGA IN connector should be connected to the VGA IN port. Note that it should be inserted tightly, with the screws on both sides securely fastened to ensure proper connection of the signal wire for achieving optimal display effect.
- The AUDIO IN connector should be connected to the AUDIO IN port and CANNOT be connected to AUDIO OUT or other ports like BNC, RCA; otherwise, it will lead to mute output and even DAMAGE the port.
- Install the projector above 200cm to avoid damage.
- The power cord and signal cable should be connected before power on the projector. During the projector starting and operating process, DO NOT insert or remove the signal cable or the power cord to avoid damaging the projector.

Cooling notes

Air outlet

- Make sure the air outlet is 50cm clear of any obstruction to ensure proper cooling.
- Air outlet location should not be in front of the lens of other projector to avoid causing illusions.
- Keep the outlet at least 100cm away from the inlets of other projectors
- The projector generates a massive amount of heat during use. The internal fan dissipates the heat of the projector when shutting down, and such process may continue for a certain period. After the project enters STANDBY MODE status, press the AC power button to turn off the projector and remove the power cord. **DO NOT** remove the power cord during the shutdown process, as it may cause damage to the projector. In the meantime, the delayed heat radiating will also affect the service life of the projector. The shutdown process may vary depending on the model used. Whatever the case may be, be sure to disconnect the power cord till after the projector enters the STANDBY status.

Air inlet

- Make sure there is no object blocking air input within 30 cm.
- Keep the inlet away from other heat sources
- Avoided heavy dust area

Power Safety

- Only use the supplied power cord.
- Do not place anything on the power cord. Place the power cord where it will not be in the way of foot traffic.
- Remove the batteries from the remote control when storing or not in use for a prolonged period.

Replacing the Lamp

Replacing the lamp can be hazardous if done incorrectly. See [Replacing the Projection Lamp](#) on page 46 for clear and safe instructions for this procedure. Before replacing the lamp:

- Unplug the power cord.
- Allow the lamp to cool for about one hour.



Caution:

In rare cases the lamp bulb may burn out during normal operation and cause glass dust or shards to be discharged outward from the rear exhaust vent.

Do not inhale or do not touch glass dust or shards. Doing so could result in injury.

Always keep your face away from the exhaust vent so that you do not suffer from the gas and broken shards of the lamp.

Cleaning the Projector

- Unplug the power cord before cleaning. See [Cleaning the Projector](#) on page 51.
- Allow the lamp to cool for about one hour.

Regulatory Warnings

Before installing and using the projector, read the regulatory notices in the [Regulatory Compliance](#) section on page 65.

Important Recycle Instructions:



Lamp(s) inside this product contain mercury. This product may contain other electronic waste that can be hazardous if not disposed of properly. Recycle or dispose in accordance with local, state, or federal Laws. For more information, contact the Electronic Industries Alliance at WWW.EIAE.ORG. For lamp specific disposal information check WWW.LAMPRECYCLE.ORG.

Symbol Explanations



DISPOSAL: Do not use household or municipal waste collection services for disposal of electrical and electronic equipment. EU countries require the use of separate recycling collection services.

About this manual

This manual is intended for end users and describes how to install and operate the DLP projector. Wherever possible, relevant information—such as an illustration and its description—has been kept on one page. This printer-friendly format is both for your convenience and to help save paper, thereby protecting the environment. It is suggested that you only print sections that are relevant to your needs.

Table of Contents

GETTING STARTED..... 1

 PACKING CHECKLIST 1

 VIEWS OF PROJECTOR PARTS..... 2

Front-right View 2

Limited lens shift..... 3

Top view—On-screen Display (OSD) buttons and LEDs..... 4

Rear view..... 5

Bottom view..... 7

 REMOTE CONTROL PARTS 8

 REMOTE CONTROL OPERATING RANGE..... 10

 PROJECTOR AND REMOTE CONTROL BUTTONS..... 10

SETUP AND OPERATION..... 11

 INSERTING THE REMOTE CONTROL BATTERIES 11

 STARTING AND SHUTTING DOWN THE PROJECTOR..... 12

 SETTING AN ACCESS PASSWORD (SECURITY LOCK) 13

 ADJUSTING THE PROJECTOR LEVEL 15

 ADJUSTING THE FOCUS AND KEYSTONE 16

 ADJUSTING THE VOLUME 16

ON-SCREEN DISPLAY (OSD) MENU SETTINGS 17

 OSD MENU CONTROLS 17

Navigating the OSD..... 17

 SETTING THE OSD LANGUAGE 18

 OSD MENU OVERVIEW 19

 IMAGE MENU..... 22

Computer Menu..... 23

Advanced Feature..... 24

Color Manager..... 25

 SETTINGS 1 MENU 26

Audio..... 27

Advanced 1 Feature..... 28

Advanced 2 Feature..... 30

 SETTINGS 2 MENU 31

Status..... 32

Advanced 1 Feature..... 33

Advanced 2 Feature..... 44

MAINTENANCE AND SECURITY 46

 REPLACING THE PROJECTION LAMP..... 46

Resetting the Lamp..... 48

 CLEANING THE FILTER (FILTER: OPTIONAL PARTS) 49

 REPLACING THE FILTER 50

 CLEANING THE PROJECTOR..... 51

Cleaning the Projector Mirror..... 51

Cleaning the Case..... 52

 USING THE PHYSICAL LOCK 53

Using the Kensington Security Slot..... 53

Using the Security Bar..... 53

TROUBLESHOOTING 54

 COMMON PROBLEMS AND SOLUTIONS 54

 TIPS FOR TROUBLESHOOTING 54

 LED ERROR MESSAGES..... 55

 IMAGE PROBLEMS..... 55

 LAMP PROBLEMS 56

 REMOTE CONTROL PROBLEMS 56

 AUDIO PROBLEMS 56

HAVING THE PROJECTOR SERVICED	57
HDMI Q & A	58
SPECIFICATIONS	59
SPECIFICATIONS	59
PROJECTION DISTANCE VS. PROJECTION SIZE.....	60
<i>Projection Distance and Size Table</i>	60
TIMING MODE TABLE.....	61
PROJECTOR DIMENSIONS (D756USTi)	63
PROJECTOR DIMENSIONS (D757WT).....	64
REGULATORY COMPLIANCE.....	65
FCC WARNING.....	65
CANADA	65
SAFETY CERTIFICATIONS.....	65
APPENDIX I.....	66
RS-232C PROTOCOL.....	66

GETTING STARTED

Packing Checklist

Carefully unpack the projector and check that the following items are included:

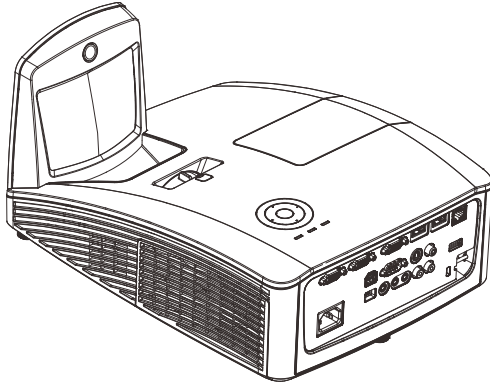

INTERACTIVE PROJECTOR (D756UST1)

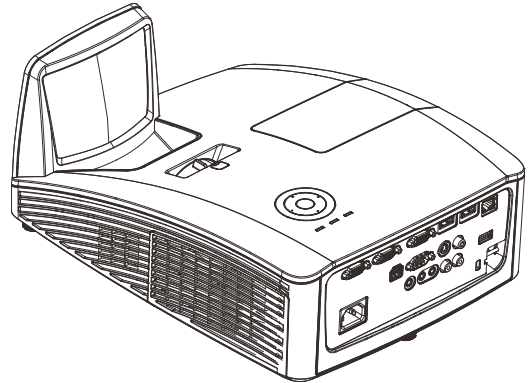

DLP PROJECTOR (D757WT)

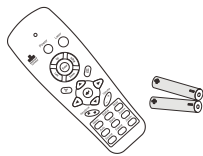

REMOTE CONTROL
(WITH TWO AAA BATTERIES)

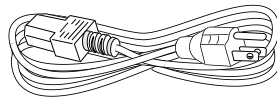

POWER CORD

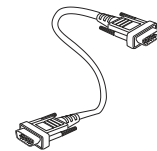

VGA CABLE



CD-ROM
(THIS USER'S MANUAL)



QUICK START CARD



WARRANTY CARD

THE FOLLOWING ITEMS ONLY FOR D756UST1



CD-ROM
(INTERACTIVE DRIVER AND
SOFTWARE)



USB CABLE
(A-TAPE TO MINI)

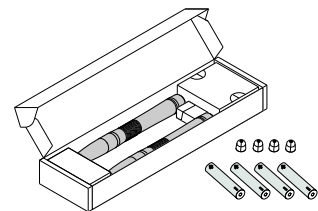

PENS BOX
(WITH FOUR AAA BATTERIES
& FOUR TIPS)

Contact your dealer immediately if any items are missing, appear damaged, or if the unit does not work. It is recommended that you keep the original packing material should you ever need to return the equipment for warranty service.



Caution:

Avoid using the projector in dusty environments.

Views of Projector Parts

Front-right View

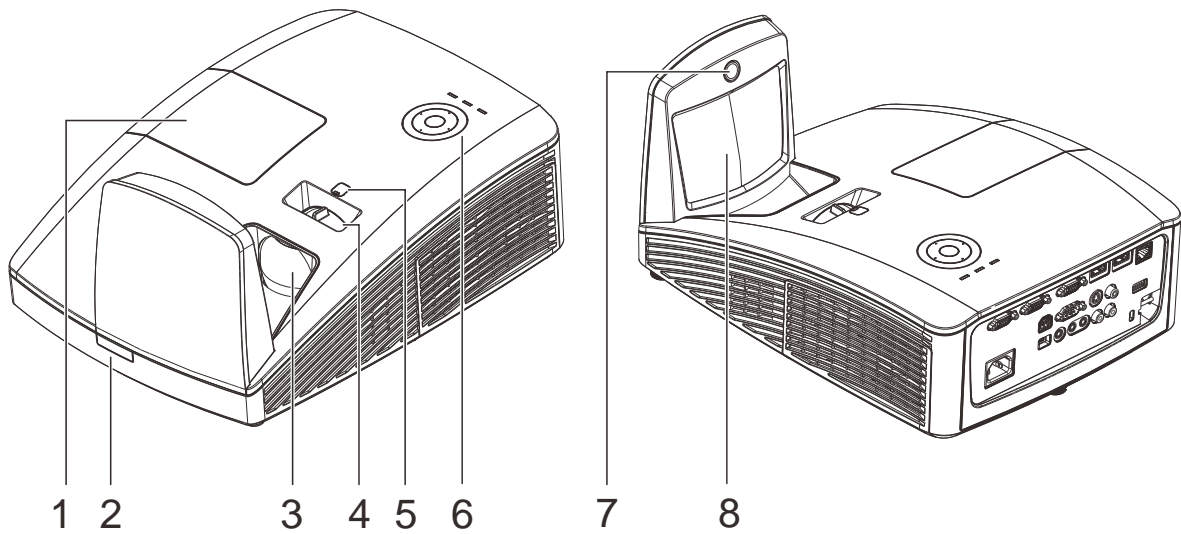

ITEM	LABEL	DESCRIPTION	SEE PAGE:
1.	Lamp cover	Removes cover to replace lamp module	
2.	IR receiver	Receives IR signal from remote control	
3.	Lens	Projection Lens	
4.	Focus ring	Focuses the projected image	
5.	Manual Lens shift	For Image vertical shift adjustment	
6.	Function keys	See Top view—On-screen Display (OSD) buttons and LEDs.	4
7.	Interactive Camera	Interactive function use Note: Only available in D756USTi	
8.	Aspheric mirror	Reflects images	



Important:

Ventilation openings on the projector allow for good air circulation, which keeps the projector lamp cool. Do not obstruct any of the ventilation openings.

Limited lens shift

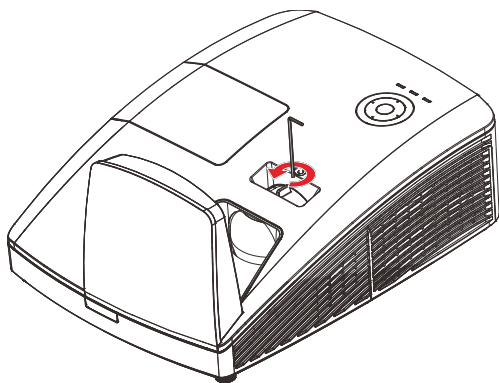
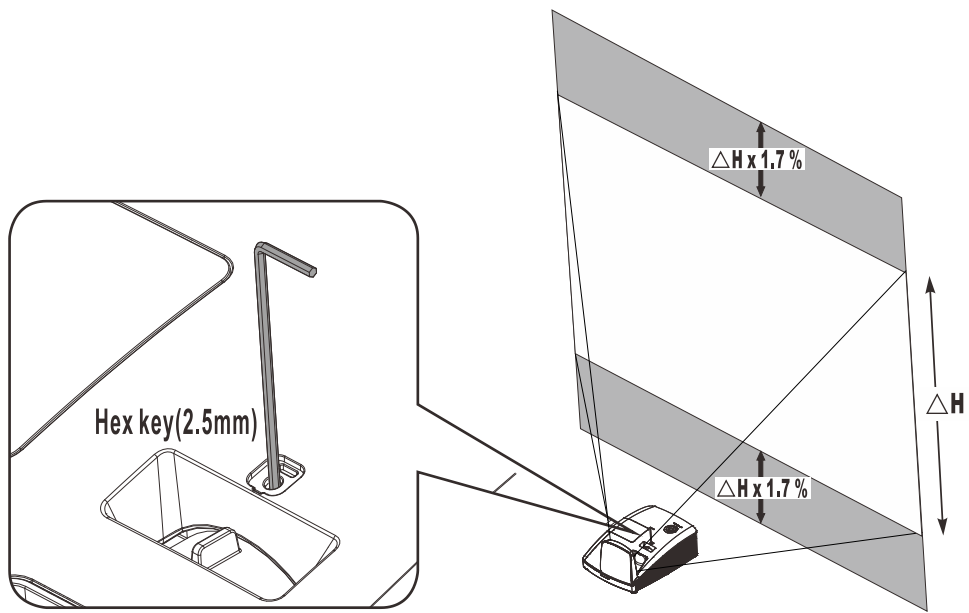

To shift up the projection image, twist the adjusters counter clockwise

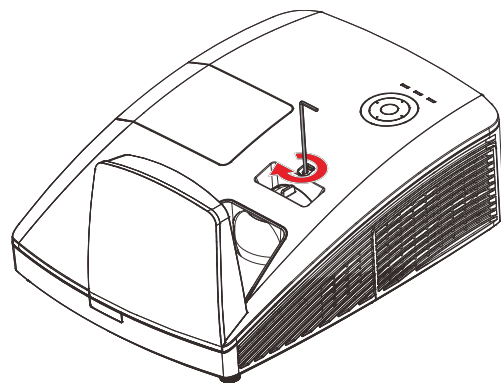

To shift down the projection image, twist the adjusters clockwise

Top view—On-screen Display (OSD) buttons and LEDs

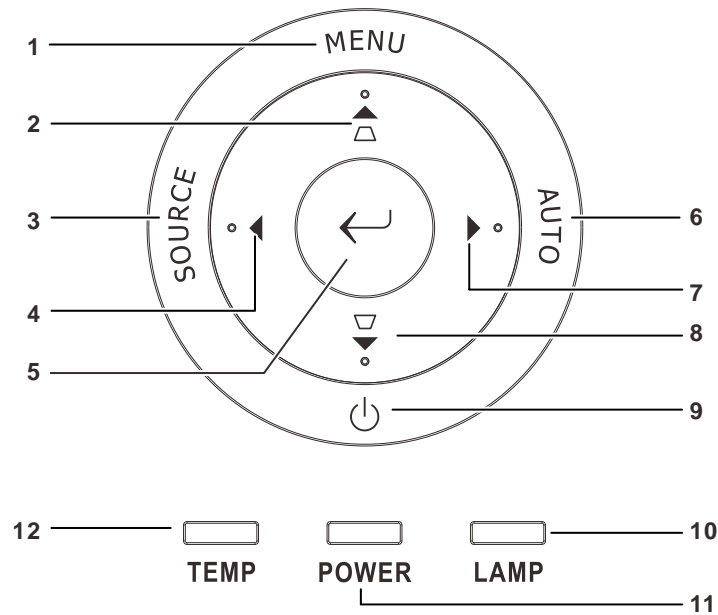

ITEM	LABEL	DESCRIPTION		SEE PAGE:
1.	MENU	Opens and exits OSD menus		17
2.	▲ △	Navigates in the OSD Quick Menu – For Keystone		
3.	SOURCE	Enter the Source menu		
4.	◀	Navigates and changes settings in the OSD		17
5.	←	Enter or confirm highlighted OSD menu item		
6.	AUTO	Optimizes image size, position, and resolution		
7.	▶	Navigates and changes settings in the OSD		17
8.	▽ ▼	Navigates in the OSD Quick Menu – For Keystone		
9.	⏻	Turns the projector On or Off		
10.	LAMP LED	Red	Lamp Fail	55
		Flashing	Error code	
11.	POWER LED	Green	Ready to power on (Standby) Lamp Lit , System stable Over Temperature	
		Flashing	System initial, Power on, Cooling, Error code	
12.	TEMP LED	Red	Over Temperature	

Rear view

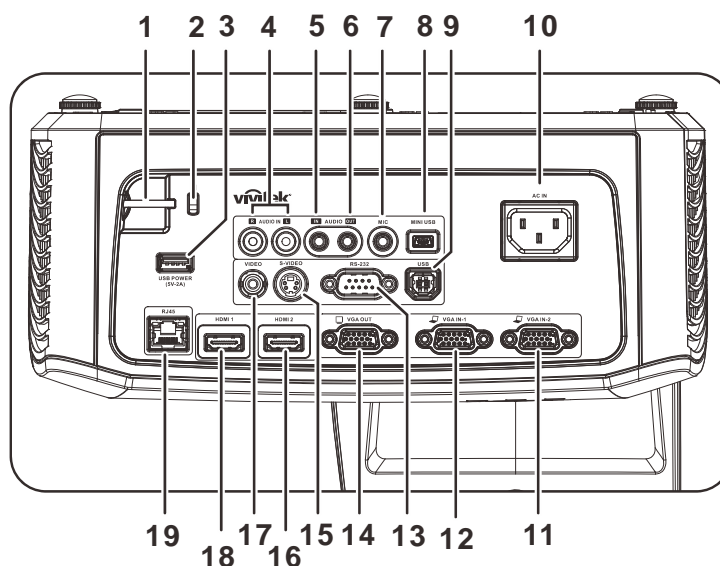

ITEM	LABEL	DESCRIPTION	SEE PAGE:
1.	Security bar	For security and authorized usage	53
2.	Kensington lock	Secure to permanent object with a Kensington Lock system	
3.	USB POWER (5V-2A)	Connect the USB cable for power supply.	
4.	AUDIO L/R (For VIDEO/ S-VIDEO)	Connect an AUDIO cable from the audio device	
5.	AUDIO IN (For VGA-1/ VGA-2)	Connect an AUDIO cable from the audio device	
6.	AUDIO OUT	Connect an AUDIO cable to an audio amplifier	
7.	MIC	Connect the Microphone for use	
8.	Mini USB	Connect the USB cable to PC Note: Only available in D756USTi	
9.	USB	Connect the USB cable from a computer	
10.	AC IN	Connect the POWER cable	12
11.	VGA – 2	Connect the RGB cable from a computer or components device	
12.	VGA – 1	Connect the RGB cable from a computer or components device	
13.	RS-232	Connect RS-232 serial port cable for remote control	
14.	VGA OUT	Connect the RGB cable to a display (Loop Thru only for VGA IN-1)	
15.	S-VIDEO	Connect the S-video cable from a video device	
16.	HDMI 2	Connect the HDMI cable from a HDMI device	
17.	VIDEO	Connect the composite cable from a video device	
18.	HDMI 1	Connect the HDMI cable from a HDMI device	
19.	RJ – 45	Connect a LAN cable from Ethernet	

Note:

If your video equipment has various input sources, it is recommended to connect in priority of HDMI/DVI, component (thru VGA), Composite for better picture quality.

Note:

*User should install driver before used Interactive function.
For more detail see driver disc.*



Warning:

As a safety precaution, disconnect all power to the projector and connecting devices before making connections.

Bottom view

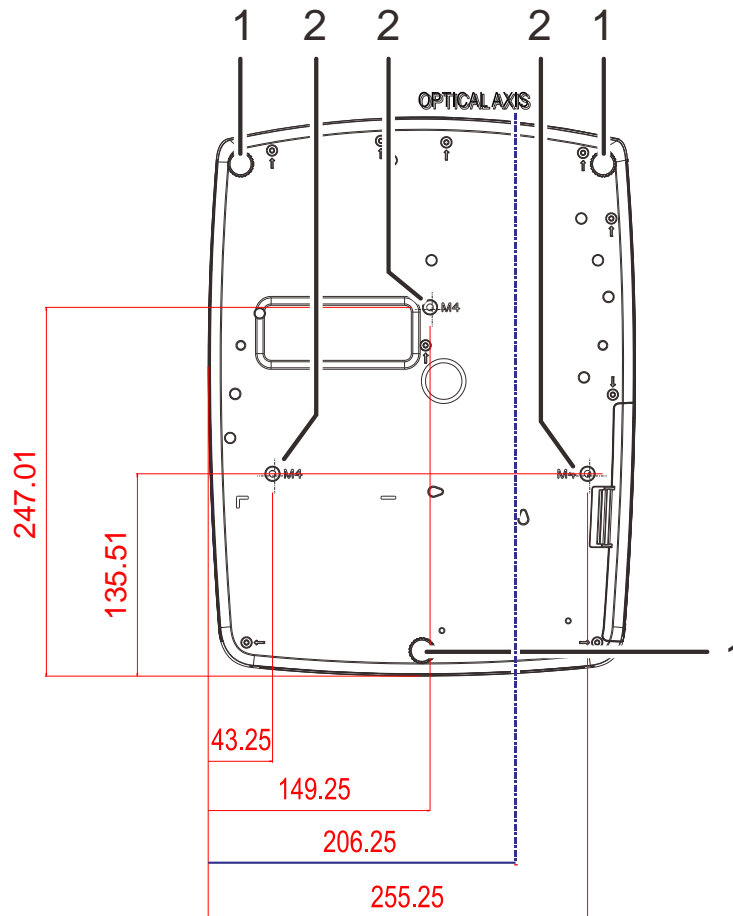

ITEM	LABEL	DESCRIPTION	SEE PAGE:
1.	Tilt adjuster	Rotate adjuster lever to adjust angle position	15
2.	Ceiling support holes	Contact your dealer for information on mounting the projector on a ceiling	

Note:
 When installing, ensure that you use only UL Listed ceiling mounts.
 For ceiling installations, use approved mounting hardware and M4 screws with a maximum screw depth of 12 mm (0.47 inch).
 The construction of the ceiling mount must be of a suitable shape and strength. The ceiling mount load capacity must exceed the weight of the installed equipment, and as an additional precaution be capable of withstanding three times the weight of the equipment (not less than 5.15 kg) over a period of 60 seconds.

Remote Control Parts

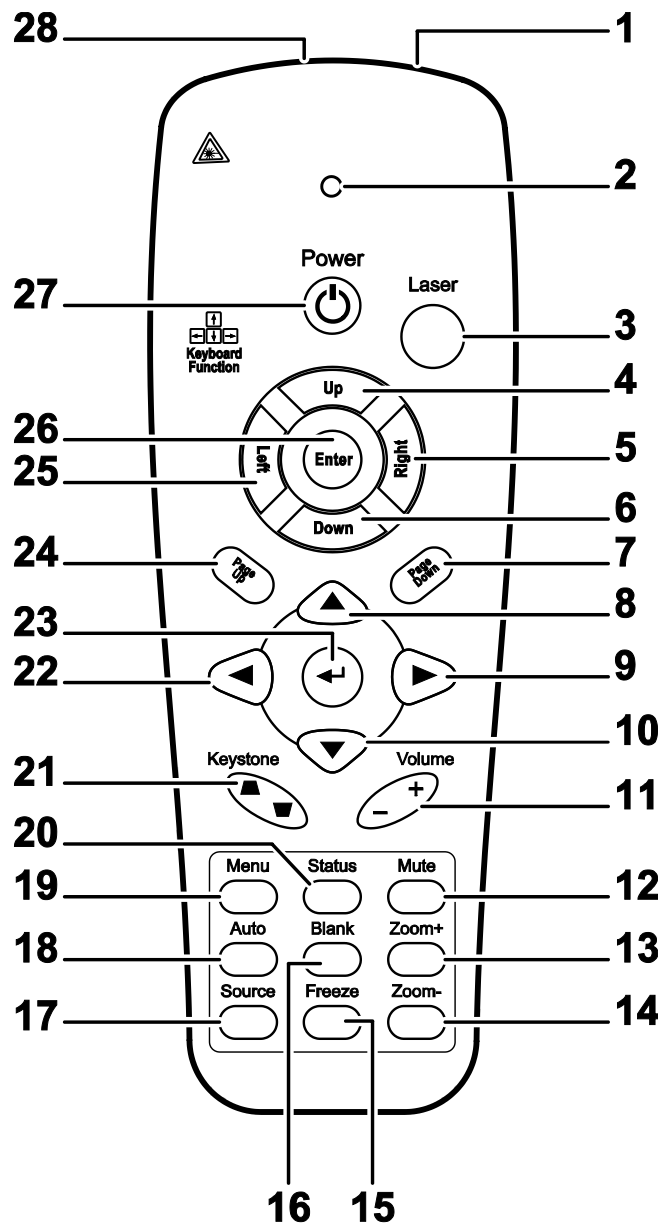

Important:

1. Avoid using the projector with bright fluorescent lighting turned on. Certain high-frequency fluorescent lights can disrupt remote control operation.
2. Be sure nothing obstructs the path between the remote control and the projector. If the path between the remote control and the projector is obstructed, you can bounce the signal off certain reflective surfaces such as projector screens.
3. The buttons and keys on the projector have the same functions as the corresponding buttons on the remote control. This user's manual describes the functions based on the remote control.

Note:

Complies with FDA performance standards for laser products except for deviations pursuant to Laser Notice No. 50, dated June 24, 2007

ITEM	LABEL	DESCRIPTION	SEE PAGE:
1.	IR transmitter	Transmits signals to projector	
2.	Status LED	Lights when the remote control is used	
3.	Laser	Press to operate the on-screen pointer	
4.	Up	Up arrow when connected through USB to a PC	
5.	Right	Right arrow when connected through USB to a PC	
6.	Down	Down arrow when connected through USB to a PC	
7.	Page Down	Page down when connected through USB to a PC	
8.	Up cursor	Navigates in the OSD	17
9.	Right cursor	Navigates and changes settings in the OSD	
10.	Down cursor	Navigates in the OSD	
11.	Volume +/-	Adjusts volume	16
12.	Mute	Mutes the built-in speaker	
13.	Zoom+	Zoom in	
14.	Zoom-	Zoom out	
15.	Freeze	Freeze/unfreezes the on-screen picture	
16.	Blank	Makes the screen blank	
17.	Source	Detects the input device	
18.	Auto	Auto adjustment for phase, tracking, size, position	
19.	Menu	Opens or exit the OSD	17
20.	Status	Opens the OSD Status menu (the menu only opens when an input device is detected)	32
21.	Keystone top/bottom	Corrects image-trapezoid (wider top/bottom) effect	16
22.	Left cursor	Navigates and changes settings in the OSD	17
23.	Enter	Changes settings in the OSD	
24.	Page Up	Page up when connected through USB to a PC	
25.	Left	Left arrow when connected through USB to a PC	
26.	Enter	Enter key when connected through USB to a PC	
27.	Power	Turns the projector on or off	12
28.	Laser	Use as on-screen pointer. DO NOT POINT IN EYES.	



Caution:

Use of controls, adjustments or performance of procedures other than those specified herein may result in hazardous laser light exposure.

Remote Control Operating Range

The remote control uses infrared transmission to control the projector. It is not necessary to point the remote directly at the projector. Provided you are not holding the remote perpendicular to the sides or the rear of the projector, the remote will function well within a radius of about 7 meters (23 feet) and 15 degrees above or below the projector level. If the projector does not respond to the remote control, move a little closer.

Projector and Remote Control Buttons

The projector can only be operated using the remote control. All operations can be carried out with the remote control.

Inserting the Remote Control Batteries

1. Remove the battery compartment cover by sliding the cover in the direction of the arrow.

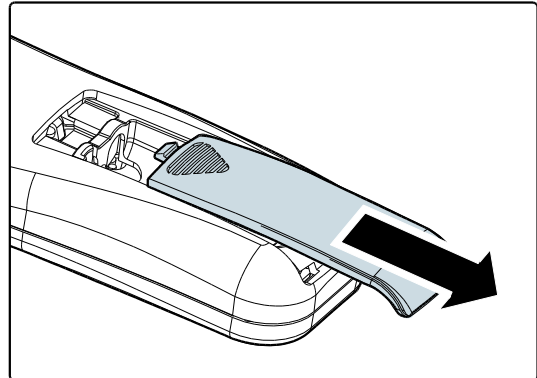

2. Insert the battery with the positive side facing up.

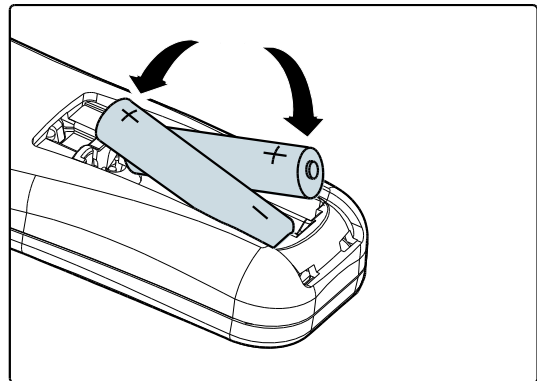

3. Replace the cover.

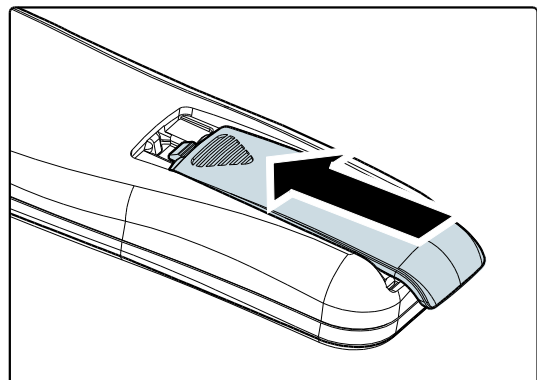

Caution:

1. Only use AAA batteries (Alkaline batteries are recommended).
2. Dispose of used batteries according to local ordinance regulations.
3. Remove the batteries when not using the projector for prolonged periods.

Starting and Shutting down the Projector

1. Connect the power cord to the projector. Connect the other end to a wall outlet.
2. Turn on the connected devices.
3. Ensure the **POWER** LED displays a solid green. Then press the **POWER** button of the remote to turn on the projector.

The projector splash screen displays and connected devices are detected.

See [Setting an Access Password \(Security Lock\)](#) on page 13 if security lock is enabled.

4. If more than one input device is connected, press the **SOURCE** button of the remote and use ▲▼ to scroll among devices. (Component is supported through the RGB to COMPONENT ADAPTER.)

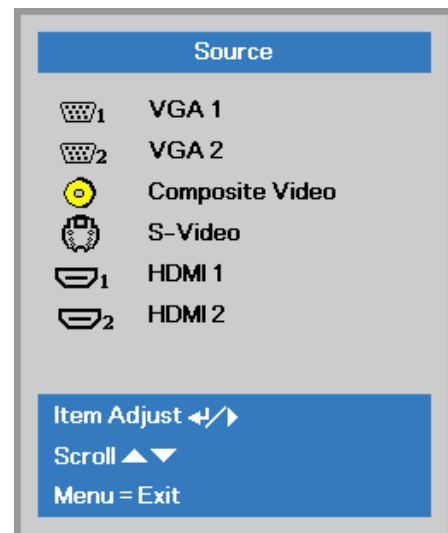
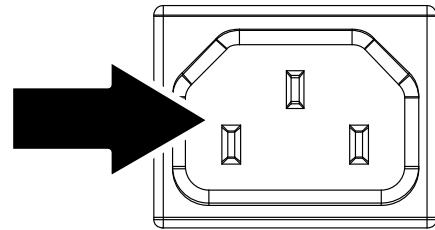

- VGA 1/VGA 2: Analog RGB
Component: DVD input YCbCr / YPbPr, or HDTV input YPbPr via HD15 connector
- Composite Video: Traditional composite video
- S-Video: Super video (Y/C separated)
- HDMI1/HDMI2: HDMI, DVI

5. When the “Power Off? /Press Power again” message appears, press the **POWER** button. The projector turns off.

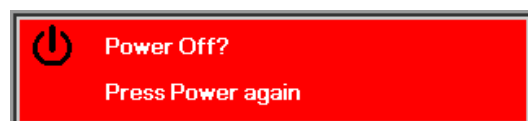

Caution:

Do not unplug the power cord until the **POWER LED** solid green—indicating the projector has cooled down.

Setting an Access Password (Security Lock)

You can use the four (arrow) buttons to set a password and prevent unauthorized use of the projector. When enabled, the password must be entered after you power on the projector. (See [Navigating the OSD](#) on page 17 and [Setting the OSD Language](#) on page 18 for help on using OSD menus.)



Important:

Keep the password in a safe place. Without the password, you will not be able to use the projector. If you lose the password, contact your reseller for information on clearing the password.

1. Press the **MENU** button to open the OSD menu.

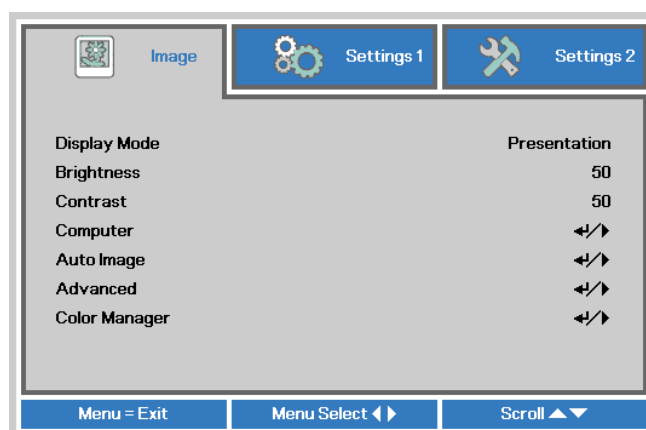

2. Press the cursor ◀▶ button to move to the **Settings 1** menu, press the cursor ▲▼ button to select **Advanced 1**.

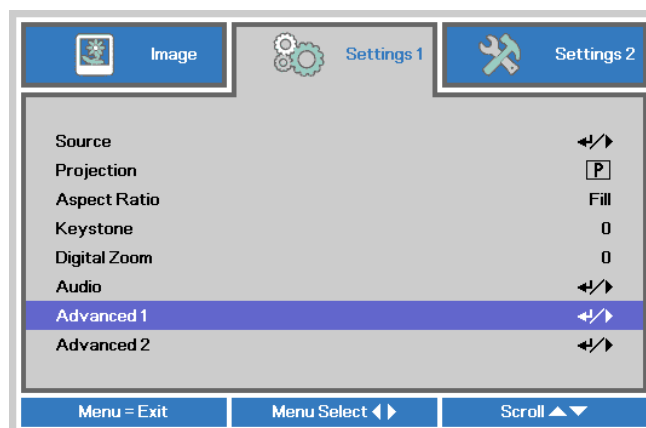

3. Press ◀ (Enter) / ▶ to enter the **Advanced 1** sub menu. Press the cursor ▲▼ button to select **Security Lock**.



4. Press the cursor ◀▶ button to enter and enable or disable security lock function.

A password dialog box automatically appears.

5. You can use the cursor buttons ▲▼◀▶ either on keypad or IR remote control for password entry. You can use any combination including the same arrow five times, but not less than five.

Press the cursor buttons in any order to set the password. Push the **MENU** button to exit the dialog box.

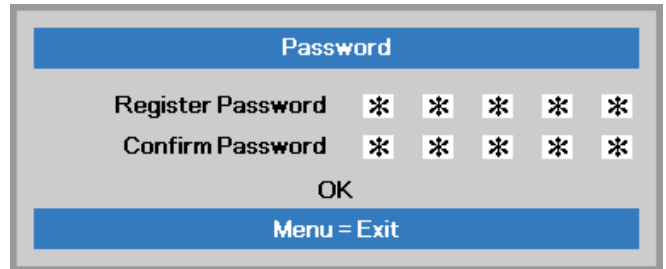
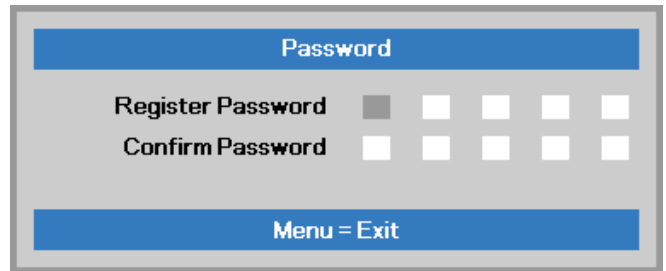

6. The password confirm menu appears when user presses the power-on key in case the **Security Lock** is enabled. Enter the password in the order you set it at step 5. In case you forget the password, please contact the service center. The service center will validate the owner and help reset the password.

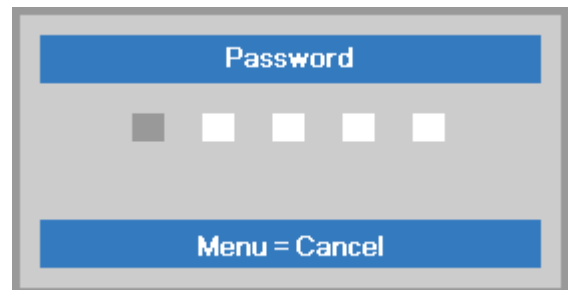

Adjusting the Projector Level

Take note of the following when setting up the projector:

- *The projector table or stand should be level and sturdy.*
- *Position the projector so that it is perpendicular to the screen.*
- *Ensure the cables are in a safe location. You could trip over them.*

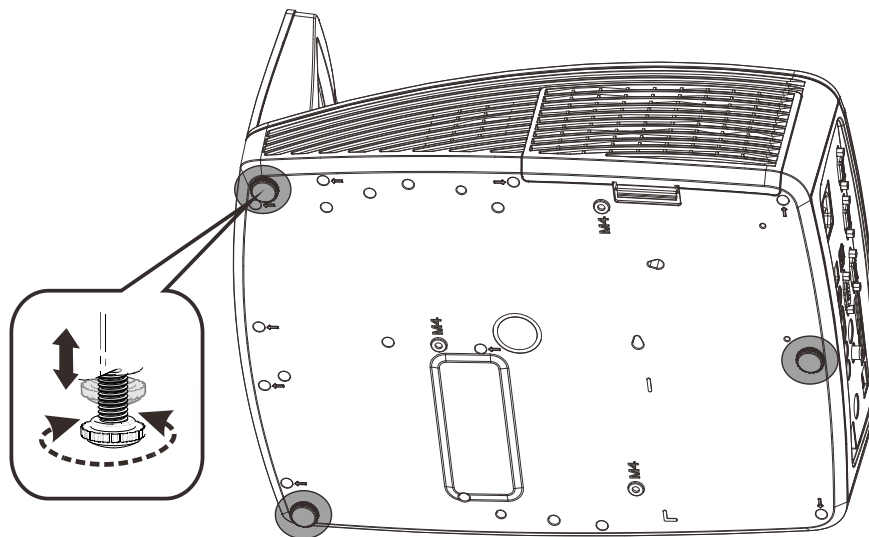

To adjust the angle of the picture, turn the tilt-adjuster right or left until the desired angle has been achieved.

Adjusting the Focus and Keystone

1. Use the **Image-focus** control (on the projector only) to sharpen the projected image

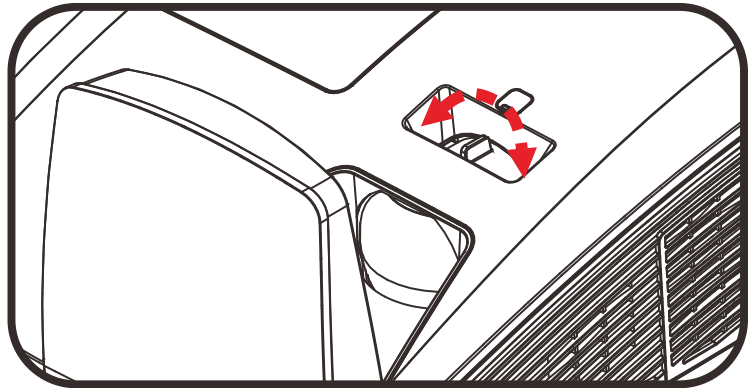

2. Use the **KEYSTONE** buttons on the remote control to correct image-trapezoid (wider top or bottom) effect.

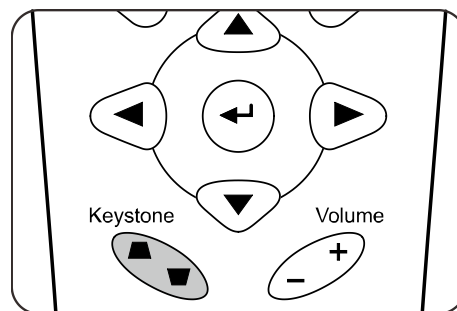

3. The keystone control appears on the display.



Adjusting the Volume

1. Press the **Volume +/-** buttons on the remote control. The volume control appears on the display.

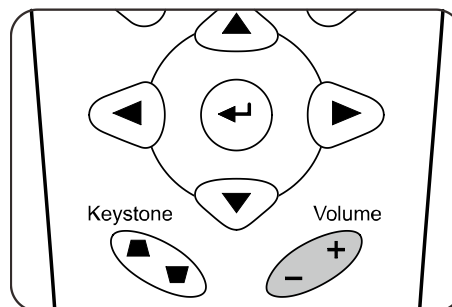

2. Press the **MUTE** button to turn off the volume. (This feature is available only on the remote).



ON-SCREEN DISPLAY (OSD) MENU SETTINGS

OSD Menu Controls

The projector has an OSD that lets you make image adjustments and change various settings.

Navigating the OSD

You can use the remote control cursor buttons to navigate and make changes to the OSD.

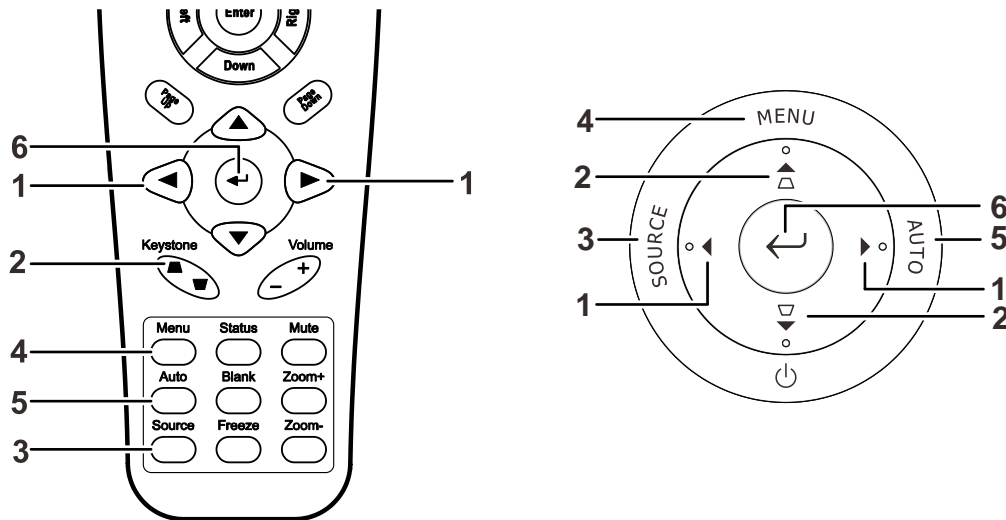

1. To enter the OSD, press the **MENU** button.
2. There are three menus. Press the cursor ◀▶ button to move through the menus.
3. Press the cursor ▲▼ button to move up and down in a menu.
4. Press ◀▶ to change values for settings.
5. Press **MENU** to close the OSD or leave a submenu.

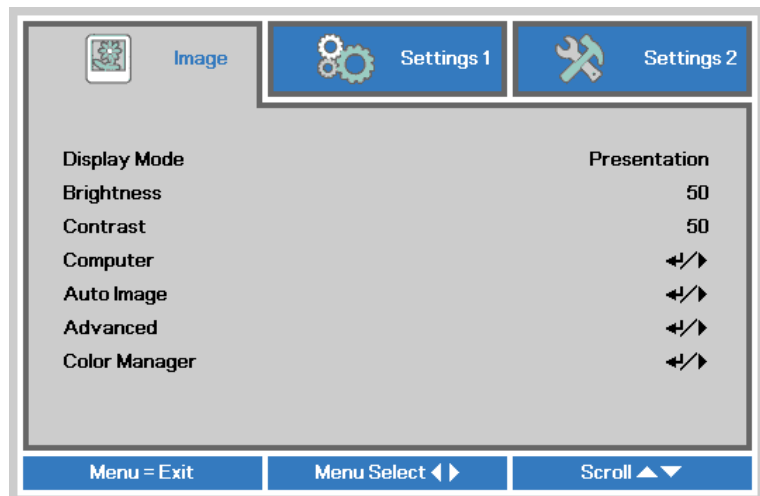

Note:

Depending on the video source, not all items in the OSD are available. For example, the **Horizontal/Vertical Position** items in the **Computer** menu can only be modified when connected to a PC. Items that are not available cannot be accessed and are grayed out.

Setting the OSD Language

Set the OSD language to your preference before continuing.

1. Press the **MENU** button. Press the cursor **◀▶** button to navigate to **Settings 1**. Press the cursor **▲▼** button to move to the **Advanced 1** menu.

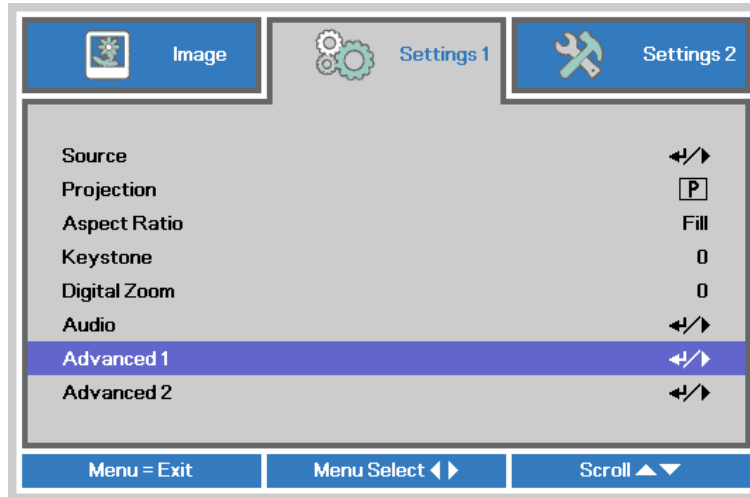

2. Press **↵** (Enter) / **▶** to enter the **Advanced 1** sub menu. Press the cursor **▲▼** button until **Language** is highlighted.

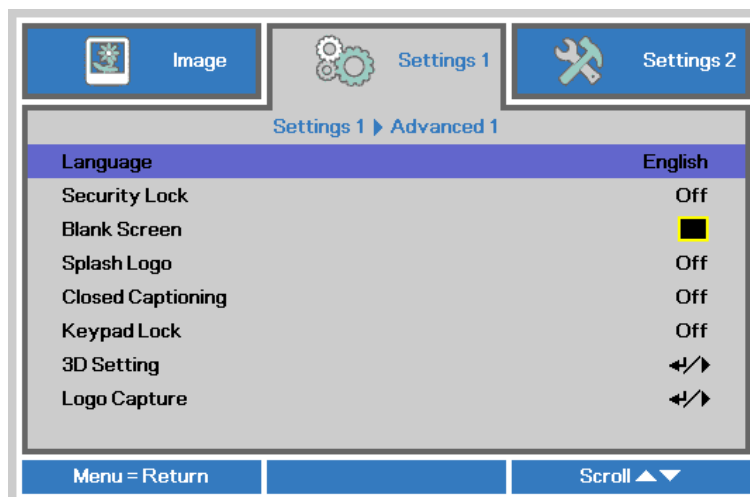

3. Press the cursor button until the language you want is highlighted.
4. Press the **MENU** button four times to close the OSD.

OSD Menu Overview

Use the following illustration to quickly find a setting or determine the range for a setting.

Main Menu	Sub Menu	Settings	
Image	Display Mode	Presentation, Bright, Game, Movie, TV, sRGB, Blackboard, User	
	Brightness	0~100	
	Contrast	0~100	
	Computer	Horizontal Position	-5~5 (depend on Autolock)
		Vertical Position	-5~5 (depend on Autolock)
		Frequency	0~31
		Tracking	-5~5
	Auto Image		
	Advanced	Brilliant Color	0~10
		Sharpness	0~31
		Gamma	1.8, 2.0, 2.2, 2.4, B&W, Linear
		Color Temperature	Warm, Normal, Cold
		Video AGC	Off, On
		Video Saturation	0~100
		Video Tint	0~100
	Color Manager	Red	Hue, Saturation, Gain 0~100
		Green	Hue, Saturation, Gain 0~100
		Blue	Hue, Saturation, Gain 0~100
		Cyan	Hue, Saturation, Gain 0~100
		Magenta	Hue, Saturation, Gain 0~100
Yellow		Hue, Saturation, Gain 0~100	
White		Red, Green, Blue 0~100	

Main Menu	Sub Menu	Settings		
Settings 1	Source	Source reference Input Source Select (IR/Keypad)		
	Projection	Normal, Real, Ceiling, Real+Ceiling		
	Aspect Ratio	Fill, 4:3, 16:9, Letter Box, Native, 2.35:1		
	Keystone	-40~40		
	Digital Zoom	-10~10		
	Audio	Volume	0~10	
		Mute	Off, On	
	Advanced 1	Language	English, Français, Deutsch, Español, Português, 簡體中文, 繁體中文, Italiano, Norsk, Svenska, Nederlands, Русский, Polski, Suomi, Ελληνικά, 한국어, Magyar, Čeština, العربية, Türkçe, Việt, 日本語, תיבטע, فارسی	
		Security Lock	Off, On	
		Blank Screen	Blank, Red, Green, Blue, White	
		Splash Logo	Std., Off, User	
		Closed Captioning	Off, On	
		KeypadLock	Off, On	
		3D Setting	3D	Off, DLP-Link, IR
			3D Sync Invert	Off, On
			3D Format	Frame Sequential, Top/Bottom, Side-By-Side, Frame Packing (3D Frame Packing HDMI source only)
		Logo Capture		
		Advanced 2	Test Pattern	None, Grid, White, Red, Green, Blue, Black
	H Image Shift		-50~50	
	V Image Shift		-50~50	

Main Menu	Sub Menu	Settings		
Settings 2	Auto Source	Off, On		
	No Signal Power Off	0~180		
	Auto Power On	Off, On		
	Lamp Mode	ECO, Normal		
	Reset All			
	Status	Active Source		
		Video Information		
		Lamp Hours(ECO, Normal)		
	Advanced 1	Menu Position	Center, Down, Up, Left, Right	
		Translucent Menu	0%, 25%, 50%, 75%, 100%	
		Low Power Mode	Off, On	
		Fan Speed	Normal, High	
		Lamp Hour Reset		
		Projector ID	00-98	
		RS232	RS232, Network	
		Network	Network State	Connect, Disconnect
			DHCP	Off, On
			IP Address	0~255, 0~255, 0~255. 0~255
			Subnet Mask	0~255, 0~255, 0~255. 0~255
			Gateway	0~255, 0~255, 0~255. 0~255
			DNS	0~255, 0~255, 0~255. 0~255
			Apply	Ok / Cancel
	Advanced 2	Sleep Timer	0~600	
		Source Filter	VGA1	Disable, Enable
			VGA2	Disable, Enable
			Composite Video	Disable, Enable
			S-Video	Disable, Enable
HDMI1			Disable, Enable	
HDMI2			Disable, Enable	

Image Menu



Attention !

All of display mode parameters when changed will be saved to user mode.

Press the **MENU** button to open the **OSD** menu. Press the cursor ◀▶ button to move to the **Image Menu**. Press the cursor ▲▼ button to move up and down in the **Image** menu. Press ◀▶ to enter and change values for settings.

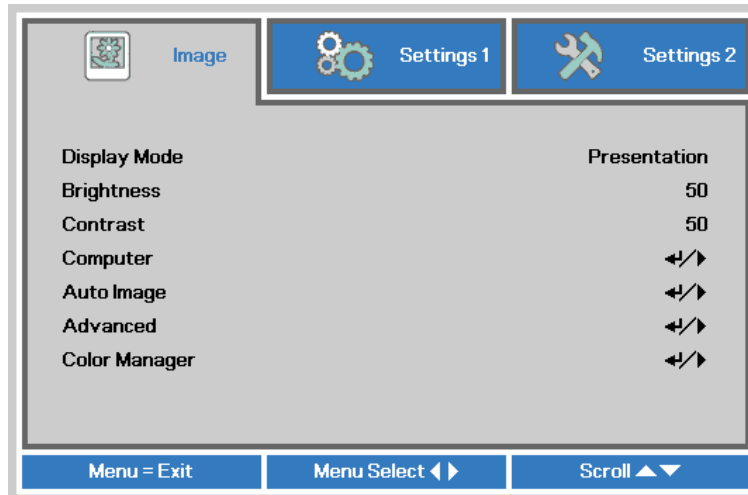

ITEM	DESCRIPTION
Display Mode	Press the cursor ◀▶ button to enter and set the Display Mode.
Brightness	Press the cursor ◀▶ button to enter and adjust the display brightness.
Contrast	Press the cursor ◀▶ button to enter and adjust the display contrast.
Computer	Press ◀ (Enter) / ▶ to enter the Computer menu. See Computer Menu on page 23.
Auto Image	Press ◀ (Enter) / ▶ to automatically adjustment for phase, tracking, size and position.
Advanced	Press ◀ (Enter) / ▶ to enter the Advanced menu. See Advanced Feature on page 24.
Color Manager	Press ◀ (Enter) / ▶ to enter the color manager menu. See page 25 for more information on Color Manager .

Computer Menu

Press the **MENU** button to open the **OSD** menu. Press ◀▶ to move to the **Image** menu. Press ▲▼ to move to the **Computer** menu and then press **Enter** or ▶. Press ▲▼ to move up and down in the **Computer** menu.

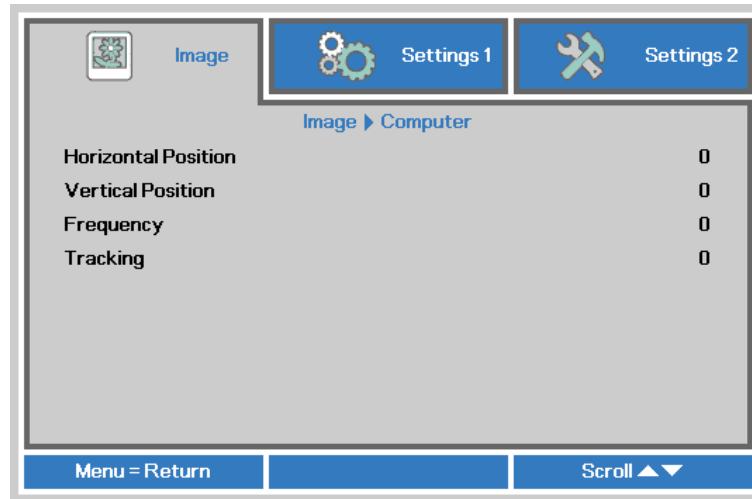

ITEM	DESCRIPTION
Horizontal Position	Press the cursor ◀▶ button to enter and adjust the display position to left or right.
Vertical Position	Press the cursor ◀▶ button to enter and adjust the display position to up or down.
Frequency	Press the cursor ◀▶ button to enter and adjust the A/D sampling clock.
Tracking	Press the cursor ◀▶ button to enter and adjust the A/D sampling dot.

Advanced Feature

Press the **Menu** button to open the **OSD** menu. Press ◀▶ to move to the **Image** menu. Press ▼▲ to move to the **Advanced** menu and then press **Enter** or ▶. Press ▼▲ to move up and down in the **Advanced** menu.

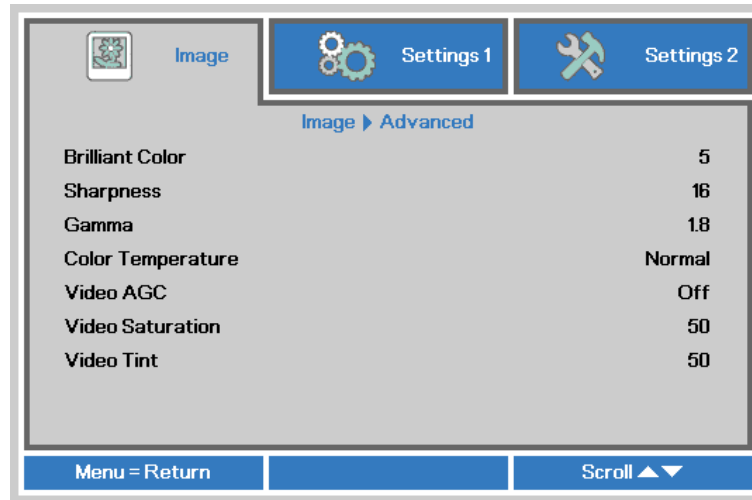

ITEM	DESCRIPTION
Brilliant Color	Press the cursor ◀▶ button to enter and adjust the Brilliant Color value.
Sharpness	Press the cursor ◀▶ button to enter and adjust the display sharpness.
Gamma	Press the cursor ◀▶ button to enter and adjust the gamma correction of the display.
Color Temperature	Press the cursor ◀▶ button to enter and adjust the color temperature.
Video AGC	Press the ◀▶ buttons to enter and enable or disable the Automatic Gain Control for video source.
Video Saturation	Press the ◀▶ buttons to enter and adjust the video saturation.
Video Tint	Press the ◀▶ buttons to enter and adjust the video tint/hue.

Color Manager

Press the **Menu** button to open the **OSD** menu. Press ◀▶ to move to the **Image** menu. Press ▼▲ to move to the **Color Manager** menu and then press **Enter** or ▶. Press ▼▲ to move up and down in the **Color Manager** menu.

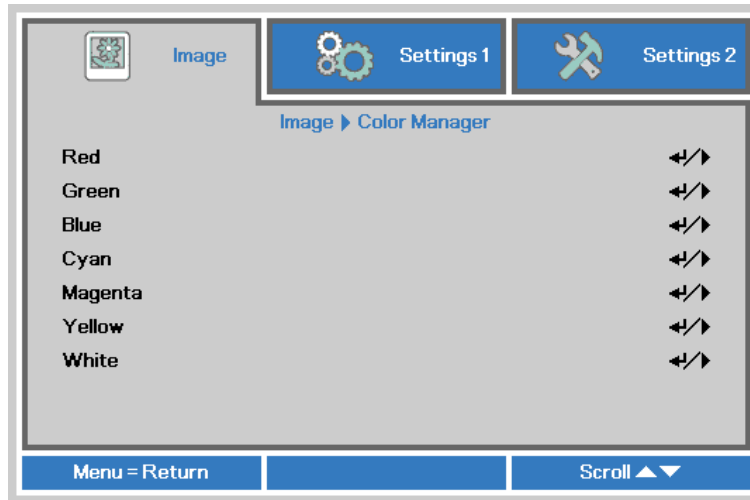

ITEM	DESCRIPTION
Red	Select to enter the Red Color Manager. Press the ◀▶ buttons to adjust the Hue, Saturation, and Gain.
Green	Select to enter the Green Color Manager. Press the ◀▶ buttons to adjust the Hue, Saturation, and Gain.
Blue	Select to enter the Blue Color Manager. Press the ◀▶ buttons to adjust the Hue, Saturation, and Gain.
Cyan	Select to enter the Cyan Color Manager. Press the ◀▶ buttons to adjust the Hue, Saturation, and Gain.
Magenta	Select to enter the Magenta Color Manager. Press the ◀▶ buttons to adjust the Hue, Saturation, and Gain.
Yellow	Select to enter the Yellow Color Manager. Press the ◀▶ buttons to adjust the Hue, Saturation, and Gain.
White	Select to enter the White Color Manager. Press the ◀▶ buttons to adjust the Red, Green, and Blue.

Settings 1 Menu

Press the **MENU** button to open the **OSD** menu. Press the cursor ◀▶ button to move to the **Settings 1** menu. Press the cursor ▲▼ button to move up and down in the **Settings 1** menu. Press ◀▶ to enter and change values for settings.

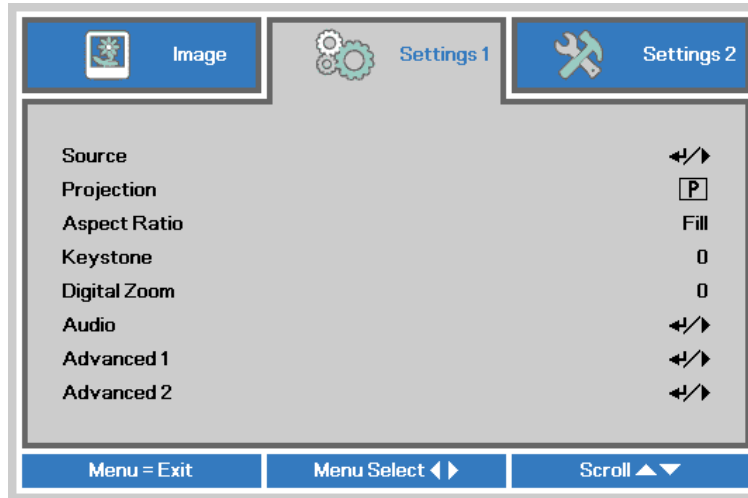

ITEM	DESCRIPTION
Source	Press the cursor ◀ (Enter) / ▶ button to enter the Source menu. Reference input Source select (IR / Keypad).
Projection	Press the cursor ◀▶ button to enter and choose from four projection methods.
Aspect Ratio	Press the cursor ◀▶ button to enter and adjust the video aspect ratio.
Keystone	Press the cursor ◀▶ button to enter and adjust the display keystone.
Digital Zoom	Press the cursor ◀▶ button to enter and adjust the Digital Zoom menu.
Audio	Press ◀ (Enter) / ▶ to enter the Audio menu. See Audio on page 27.
Advanced 1	Press ◀ (Enter) / ▶ to enter the Advanced 1 menu. See Advanced 1 Feature on page 28.
Advanced 2	Press ◀ (Enter) / ▶ to enter the Advanced 2 menu. See Advanced 2 Feature on page 30.

Audio

Press the **Menu** button to open the **OSD** menu. Press ◀▶ to move to the **Settings 1** menu. Press ▼▲ to move to the **Audio** menu and then press **Enter** or ▶. Press ▼▲ to move up and down in the **Audio** menu.

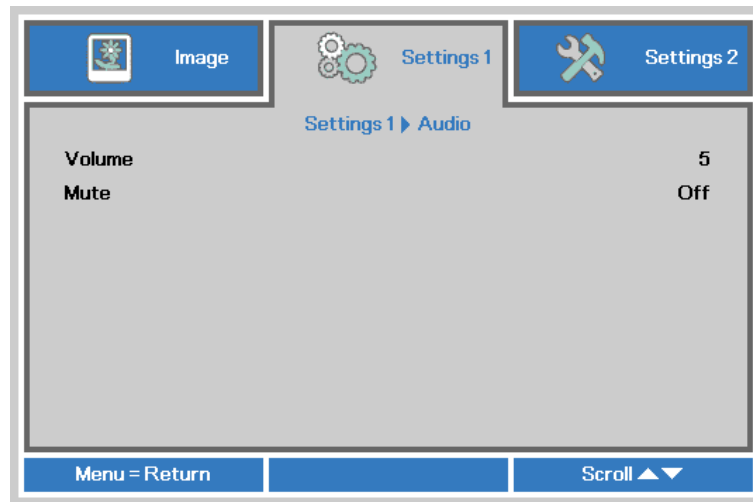

ITEM	DESCRIPTION
Volume	Press the ◀▶ buttons to enter and adjust the audio volume.
Mute	Press the ◀▶ buttons to enter and turn on or off the speaker.

Advanced 1 Feature

Press the **Menu** button to open the **OSD** menu. Press ◀▶ to move to the **Settings 1** menu. Press ▲▼ to move to the **Advanced 1** menu and then press **Enter** or ▶. Press ▲▼ to move up and down in the **Advanced 1** menu. Press ◀▶ to enter and change values for setting.

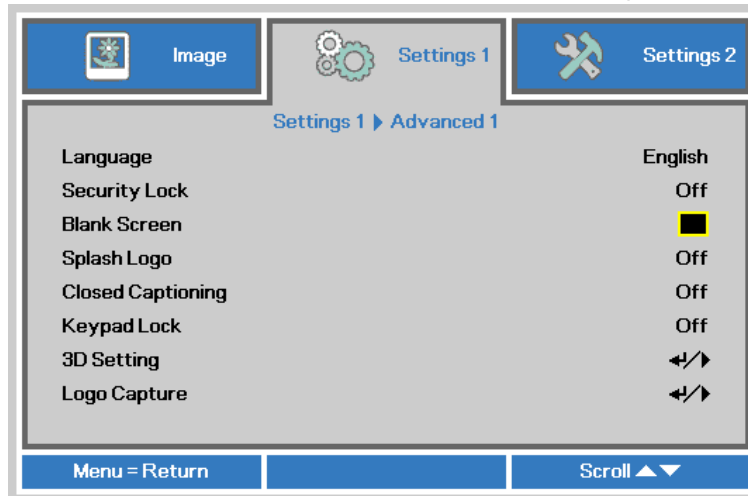

ITEM	DESCRIPTION
Language	Press the cursor ◀▶ button to enter and select a different localization Menu.
Security Lock	Press the cursor ◀▶ button to enter and enable or disable security lock function.
Blank Screen	Press the cursor ◀▶ button to enter and select different color to blank the screen.
Splash Logo	Press the cursor ◀▶ button to enter and select splash logo.
Closed Captioning	Press the cursor ◀▶ buttons to enter and enable or disable Closed Captioning
Keypad Lock	Press the cursor ◀▶ button to enter and enable or disable keys can be work on keypad.
3D Setting	Press ◀ (Enter) / ▶ to enter the 3D menu. See page 29 for more information on 3D Setting .
Logo Capture	Press ◀ (Enter) / ▶ to capture screen pattern to Logo.

Note:

To enjoy the 3D function, first enable the Play Movie in 3D setting found in your DVD device under the 3D Disc Menu.

3D Setting

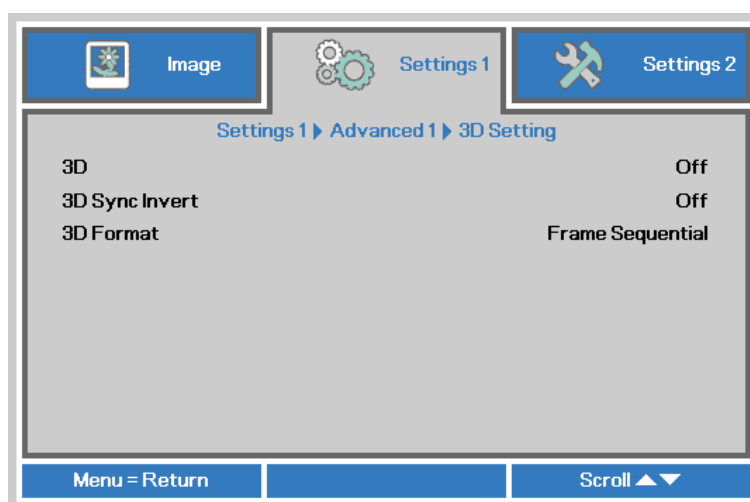

ITEM	DESCRIPTION
3D	Press the cursor ◀▶ button to enter and select different 3D mode.
3D Sync Invert	Press the cursor ◀▶ button to enter and enable or disable 3D Sync Invert.
3D Format	Press the cursor ◀▶ button to enter and enable or disable different 3D Format.

Note:

1. The 3D OSD menu item is gray if there is no appropriate 3D source. This is the default setting.
2. When the projector is connected to an appropriate 3D source, the 3D OSD menu item is enabled for selection.
3. Use 3D glasses to view a 3D image.
4. You need 3D content from a 3D DVD or 3D media file.
5. You need to enable the 3D source (some 3D DVD content may have a 3D on-off selection feature).
6. You need DLP link 3D or IR 3D shutter glasses. With IR 3D shutter glasses, you need to install a driver on your PC and connect a USB emitter.
7. The 3D mode of the OSD needs to match the type of glasses (DLP link or IR 3D).
8. Power on the glasses. Glasses normally have a power on -off switch. Each type of glasses has their own configuration instructions. Please follow the configuration instructions that come with your glasses to finish the setup process.

Note:

Since different types of glass (DLP link or IR shutter glass) have their own setting instructions, Please follow the guide to finish the setup process.

Advanced 2 Feature

Press the **Menu** button to open the **OSD** menu. Press ◀▶ to move to the **Settings 1** menu. Press ▲▼ to move to the **Advanced 2** menu and then press **Enter** or ▶. Press ▲▼ to move up and down in the **Advanced 2** menu. Press ◀▶ to enter and change values for setting.

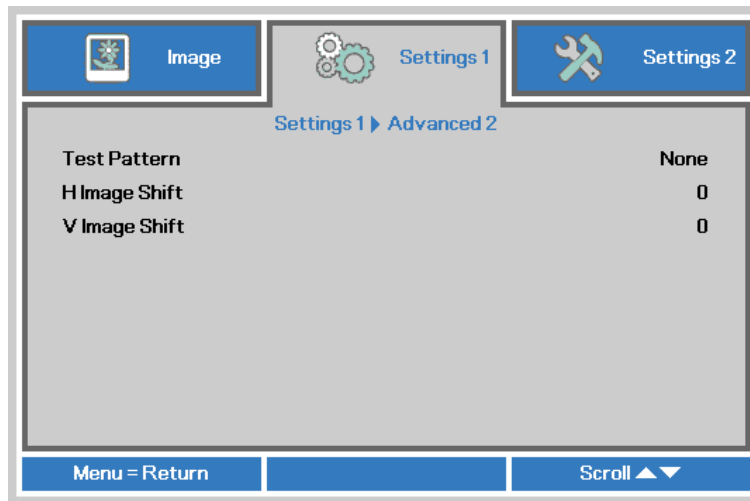

ITEM	DESCRIPTION
Test Pattern	Press the cursor ◀▶ button to enter and select internal test pattern.
H Image Shift	Press the cursor ◀▶ button to enter and select H Image Shift.
V Image Shift	Press the cursor ◀▶ button to enter and select V Image Shift.

Settings 2 Menu

Press the **MENU** button to open the **OSD** menu. Press the cursor ◀▶ button to move to the **Settings 2** menu. Press the cursor ▲▼ button to move up and down in the **Settings 2** menu.

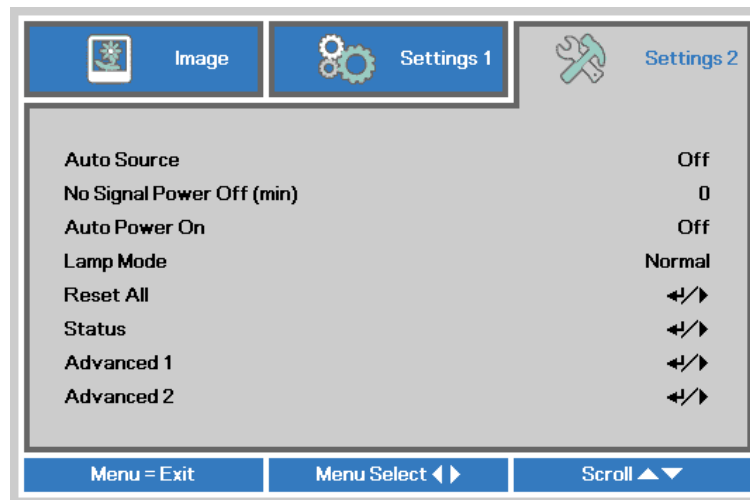

ITEM	DESCRIPTION
Auto Source	Press the cursor ◀▶ button to enter and enable or disable automatic source detection.
No Signal Power Off (min.)	Press the cursor ◀▶ button to enter and enable or disable automatic shutdown of lamp when no signal.
Auto Power On	Press the cursor ◀▶ button to enter and enable or disable automatic power On when AC power is supplied.
Lamp Mode	Press the cursor ◀▶ button to enter and select the lamp mode for higher brightness or lower brightness to save lamp life.
Reset All	Press ◀ (Enter) / ▶ to reset all settings to default values.
Status	Press ◀ (Enter) / ▶ to enter the Status menu. See page 32 for more information on Status .
Advanced 1	Press ◀ (Enter) / ▶ to enter the Advanced 1 menu. See Advanced 1 Feature on page 33.
Advanced 2	Press ◀ (Enter) / ▶ to enter the Advanced 2 menu. See Advanced 2 Feature on page 44.

Status

Press the cursor ▲ ▼ button to move up and down in the **Settings 2** menu. Select the **Status** menu and press **Enter** or ► to enter.

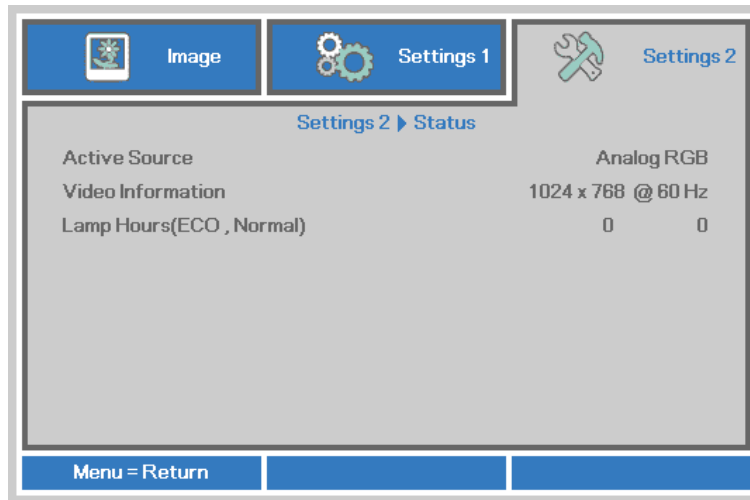

ITEM	DESCRIPTION
Active Source	Display the activated source.
Video Information	Displays resolution/video information for RGB source and color standard for Video source.
Lamp Hours	Lamp hour used information is displayed. (Eco and Normal)

Advanced 1 Feature

Press the **Menu** button to open the **OSD** menu. Press ◀▶ to move to the **Settings 2** menu. Press ▲▼ to move to the **Advanced 1** menu and then press **Enter** or ▶. Press ▲▼ to move up and down in the **Advanced 1** menu. Press ◀▶ to enter and change values for setting.

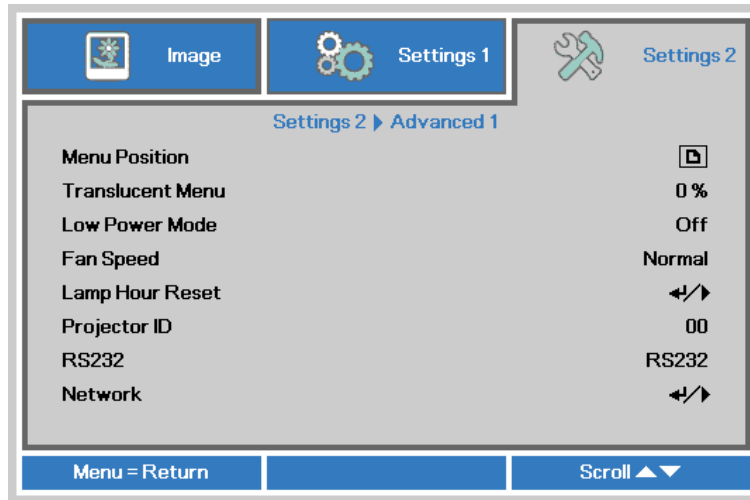

ITEM	DESCRIPTION
Menu Position	Press ◀▶ button to enter and select different OSD location.
Translucent Menu	Press ◀▶ button to enter and select OSD background translucent level.
Low Power Mode	Press ◀▶ to enter and turn Low Power Mode on or off.
Fan Speed	Press the cursor ◀▶ button to enter and toggle between Normal and High fan speeds. Note: We recommend selecting high speed in high temperatures, high humidity, or high altitude (higher than 1500m/4921ft) areas.
Lamp Hour Reset	After replacing the lamp, this item should be reset. See page 34 for more information on Lamp Hour Reset .
Projector ID	Press the cursor ◀▶ button to enter and adjust a two digit projector ID from 00 through 98.
RS232	Press ◀▶ to select RS232 (remote) or Network (LAN) mode depending on projector connection method.
Network	Press ◀ (Enter) / ▶ to enter the Network menu. See page 34 for more information on Network .

Note:

To enjoy Network function on Low Power Stand-By, Please let Low Power Mode set On, and RS232 set Network.

Lamp Hour Reset

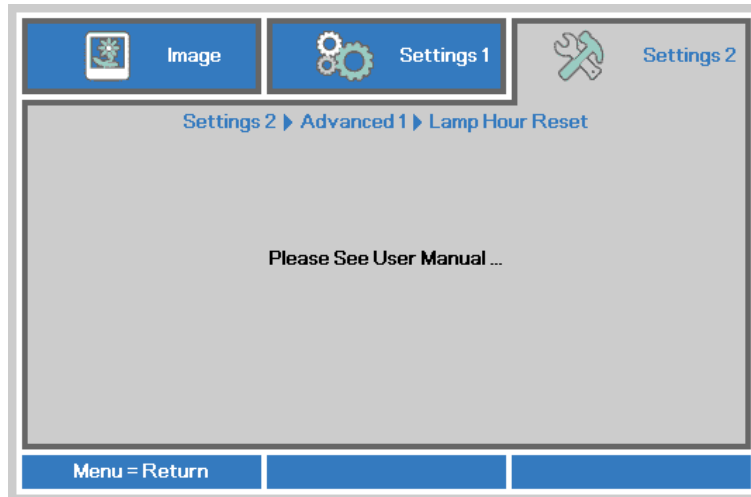

Please refer to [Resetting the Lamp](#) on page 48 to reset the lamp hour counter.

Network

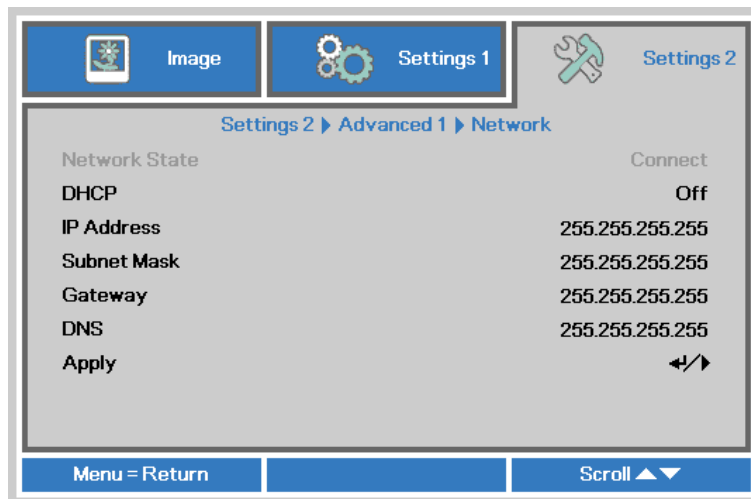

ITEM	DESCRIPTION
Network State	Displays the network connection status.
DHCP	Press ◀▶ to turn DHCP On or Off. Note: If you select DHCP Off, complete the IP Address, Subnet Mask, Gateway, and DNS fields.
IP Address	Enter a valid IP address if DHCP is turned off.
Subnet Mask	Enter a valid Subnet Mask if DHCP is turned off.
Gateway	Enter a valid Gateway address if DHCP is turned off.
DNS	Enter a valid DNS name if DHCP is turned off.
Apply	Press ◀ (Enter) / ▶ to confirm settings.

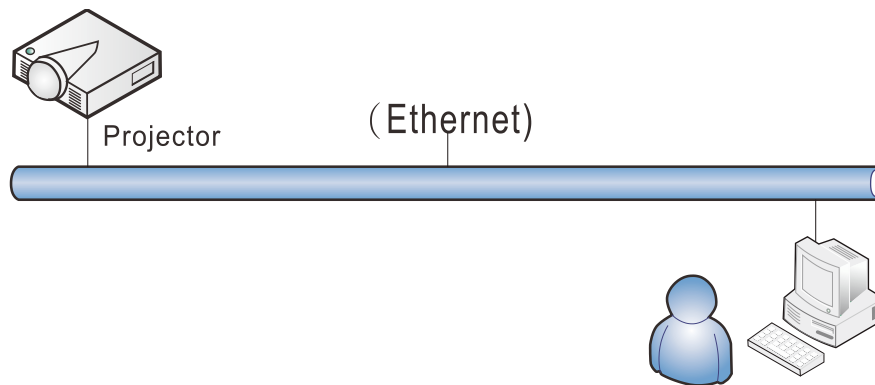

Wired LAN Terminal functionalities

Remote control and monitoring of a projector from a PC (or Laptop) via wired LAN is also possible. Compatibility with Crestron / AMX (Device Discovery) / Extron control boxes enables not only collective projector management on a network but also management from a control panel on a PC (or Laptop) browser screen.

* Crestron is a registered trademark of Crestron Electronics, Inc. of the United States.

* Extron is a registered trademark of Extron Electronics, Inc. of the United States.

* AMX is a registered trademark of AMX LLC of the United States.

Supported External Devices

This projector is supported by the specified commands of the Crestron Electronics controller and related software (ex, RoomView ®).

<http://www.crestron.com/>

This projector is supported by AMX (Device Discovery).

<http://www.amx.com/>

This projector is compliant to support Extron device(s) for reference.

<http://www.extron.com/>

For more detail of information about the diverse types of external devices which can be connected to the LAN/RJ45 port and remote/control the projector, as well as the related control commands supporting for each external device, kindly please get contact with the Support-Service team directly.

LAN RJ45

1. Connect an RJ45 cable to RJ45 ports on the projector and the PC (Laptop).

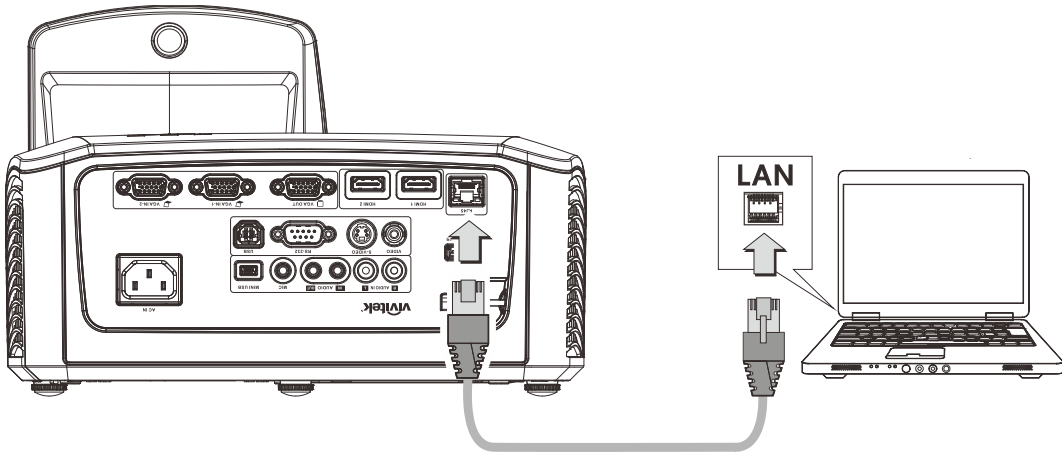

2. On the PC (Laptop), select **Start** → **Control Panel** → **Network and Internet**.

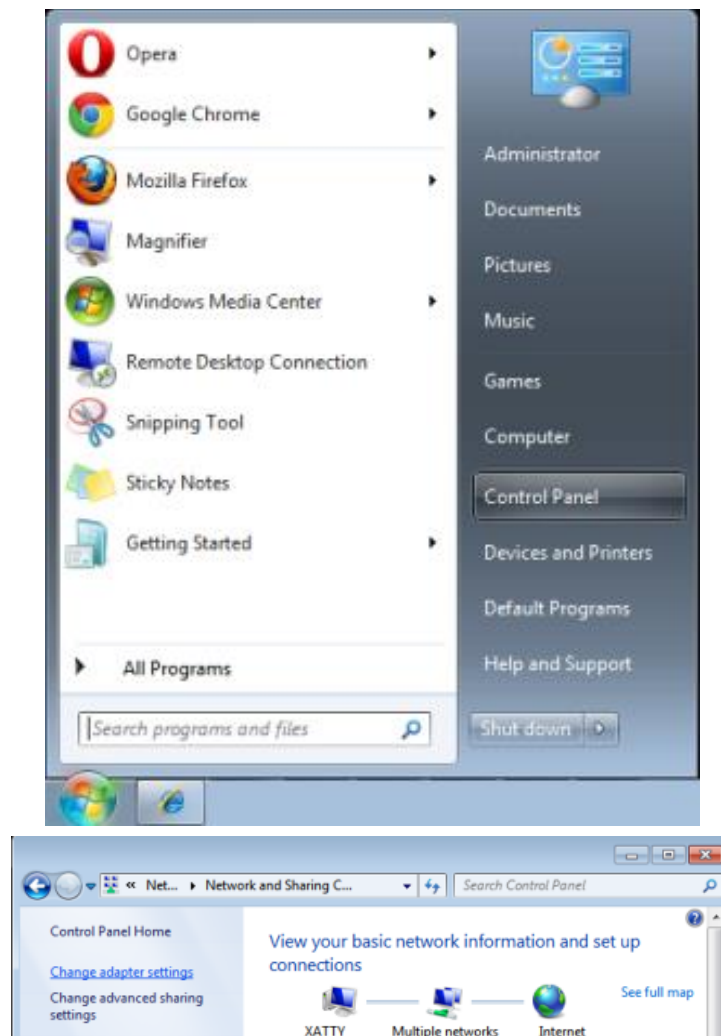

3. Right-click on **Local Area Connection**, and select **Properties**.

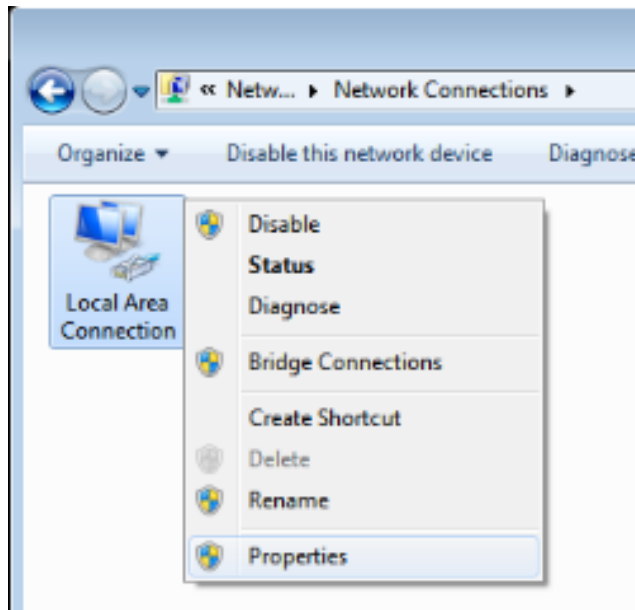

4. In the **Properties** window, select the **Networking** tab, and select **Internet Protocol (TCP/IP)**.
5. Click **Properties**.

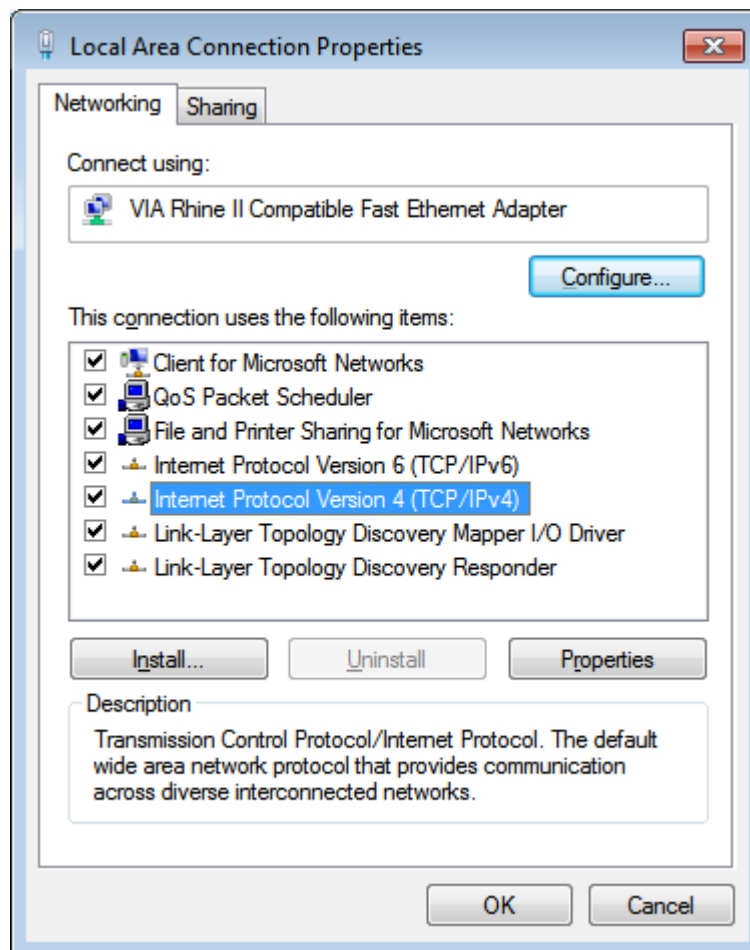

6. Click **Use the following IP address** and fill in the IP address and Subnet mask, then click **OK**.

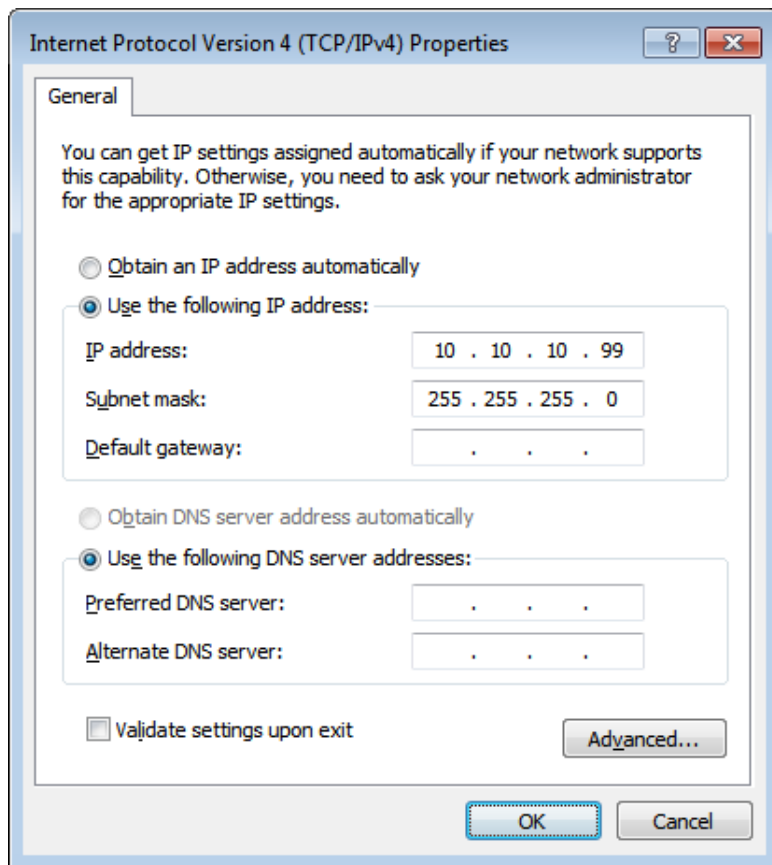

7. Press the **Menu** button on the projector.
8. Select **Settings 2** → **Advanced 1** → **RS232** → **Network** Option
9. After getting into **Network**, input the following:
- ▶ DHCP: Off
 - ▶ IP Address: 10. 10. 10. 10
 - ▶ Subnet Mask: 255.255.255.0
 - ▶ Gateway: 0.0.0.0
 - ▶ DNS Server: 0.0.0.0
10. Press **↵** (Enter) / **▶** to confirm settings.
11. Open a web browser (for example, Microsoft Internet Explorer with Adobe Flash Player 9.0 or higher).

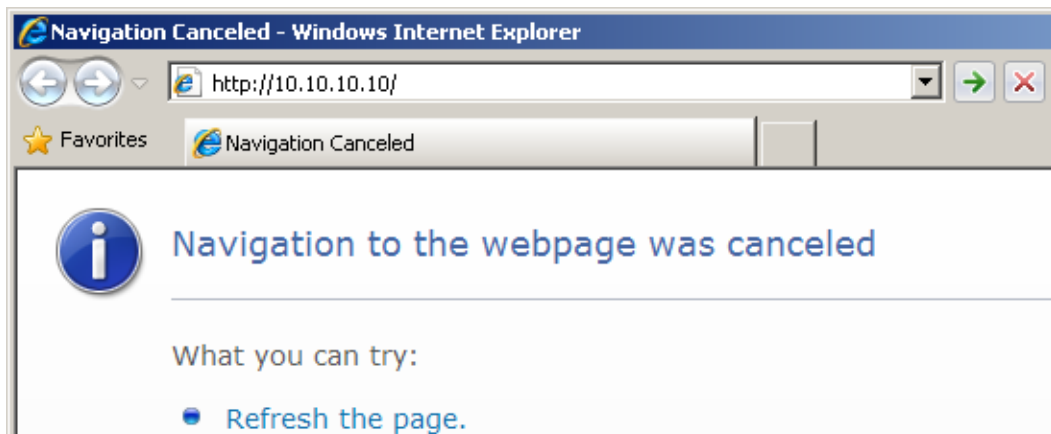

12. In the Address bar, input the IP address: 10. 10. 10. 10.

13. Press **↵** (Enter) / **▶**.

The projector is setup for remote management. The LAN/RJ45 function displays as follows.

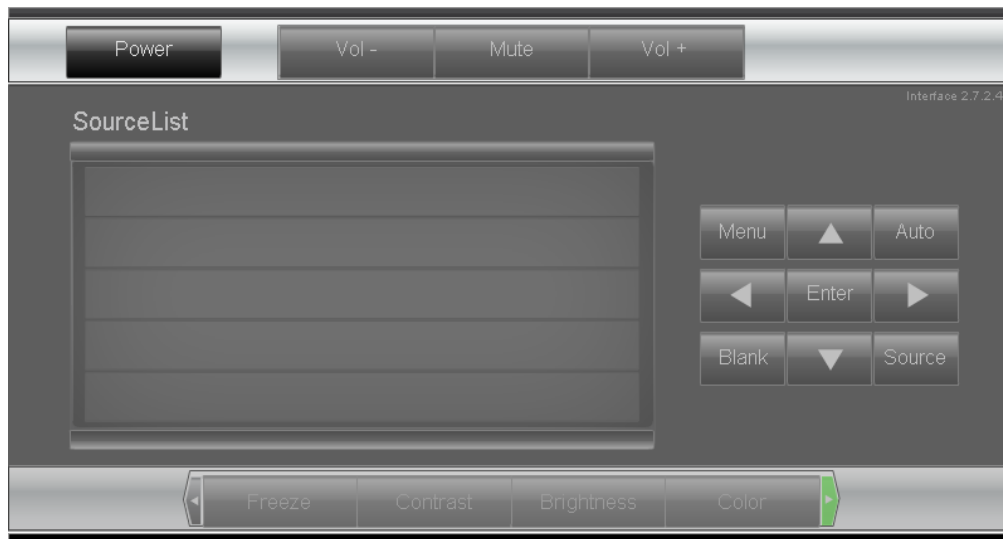

Expansion Options

Crestron Control	Projector	User Password
IP Address <input type="text"/>	Projector Name <input type="text" value="PJ01"/>	<input type="checkbox"/> Usr Enabled
IP ID <input type="text"/>	Location <input type="text" value="RM01"/>	Password <input type="text"/>
Control Port <input type="text"/>	Assigned To <input type="text" value="Sir"/>	Confirmed <input type="text"/>
<input type="button" value="Control Set"/>	<input type="button" value="Set"/>	<input type="button" value="Usr Set"/>
	Network Config <input type="checkbox"/> DHCP Enabled	
	IP Address <input type="text" value="10.10.10.10"/>	Admin Password
	Subnet Mask <input type="text" value="255.255.255.0"/>	<input type="checkbox"/> Adm Enabled
	Default Gateway <input type="text" value="0.0.0.0"/>	Password <input type="text"/>
	DNS Server <input type="text" value="0.0.0.0"/>	Confirmed <input type="text"/>
	<input type="button" value="Net Set"/>	<input type="button" value="Adm Set"/>
	<input type="button" value="Tools Exit"/>	

CATEGORY	ITEM	INPUT-LENGTH
Crestron Control	IP Address	15
	IP ID	3
	Port	5
Projector	Projector Name	10
	Location	10
	Assigned To	10
Network Configuration	DHCP (Enabled)	(N/A)
	IP Address	15
	Subnet Mask	15
	Default Gateway	15
	DNS Server	15
User Password	Enabled	(N/A)
	New Password	10
	Confirm	10
Admin Password	Enabled	(N/A)
	New Password	10
	Confirm	10

For more information, please visit <http://www.crestron.com/>.

RS232 by Telnet Function

Besides projector connected to RS232 interface with “Hyper-Terminal” communication by dedicated RS232 command control, there is alternative RS232 command control way, so called “RS232 by TELNET” for LAN/RJ45 interface.

Quick Start-Guide for “RS232 by TELNET”

Check and get the IP-Address on OSD of the projector.

Make sure that laptop/PC can access the web-page of the projector.

Make sure that “Windows Firewall” setting to be disabled in case of “TELNET” function filtering out by laptop/PC.

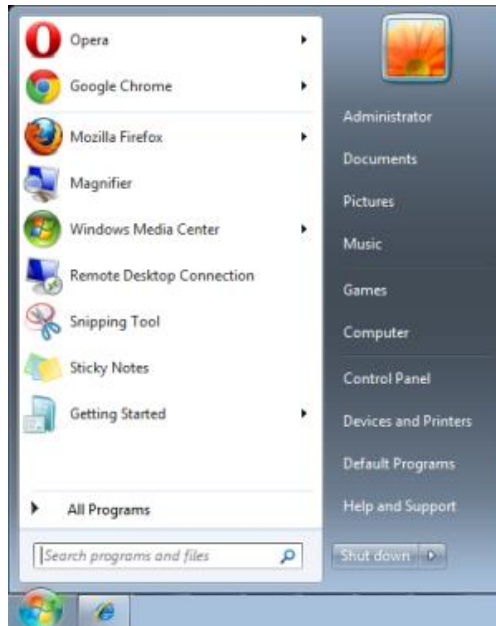

Start => All Programs => Accessories => Command Prompt

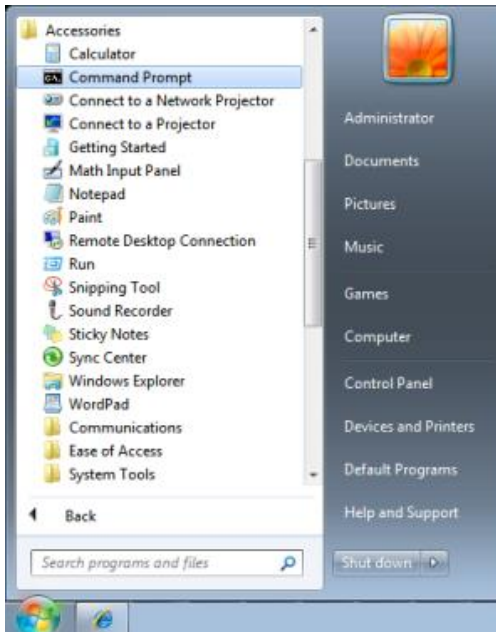

Input the command format like the below:

telnet ttt.xxx.yyy.zzz 23 (“Enter” key pressed)

(**ttt.xxx.yyy.zzz**: IP-Address of the projector)

If Telnet-Connection ready, and user can have RS232 command input, then “Enter” key pressed, the RS232 command will be workable.

How to have TELNET enabled in Windows VISTA / 7

By default installation for Windows VISTA, “TELNET” function is not included. But end-user can have it by way of “Turn Windows features On or Off” to be enabled.

Open “Control Panel” in Windows VISTA

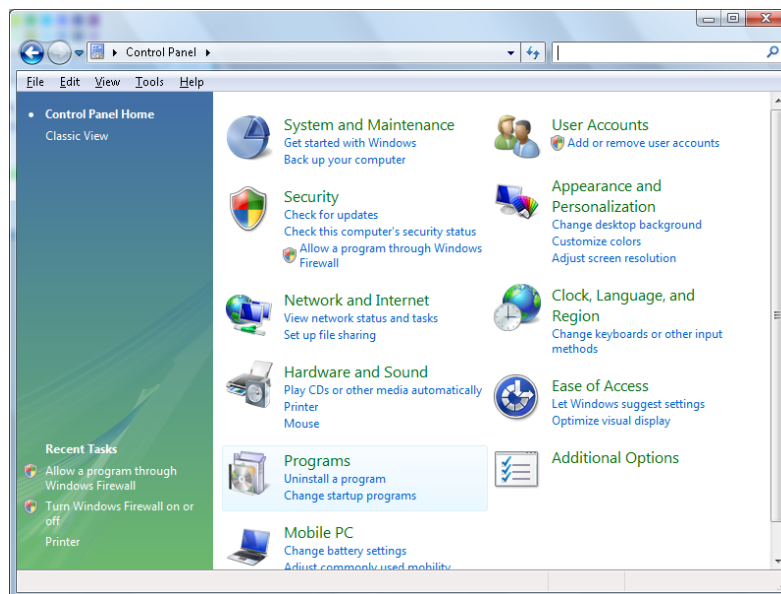

Open “Programs”

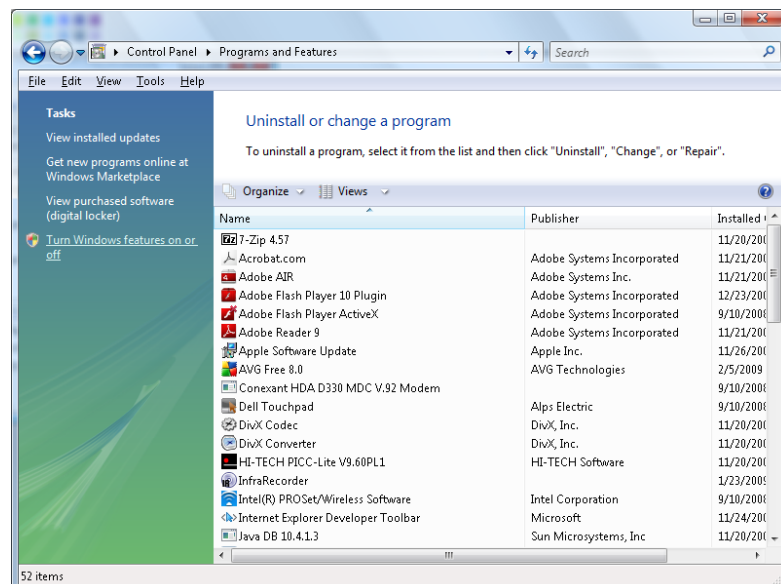

Select “Turn Windows features on or off” to open

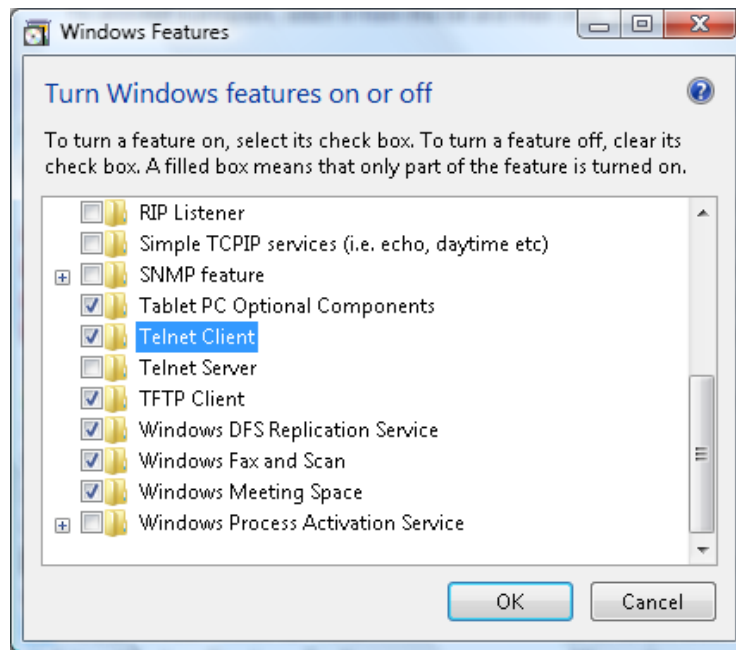

Have “Telnet Client” option checked, then press “OK” button.

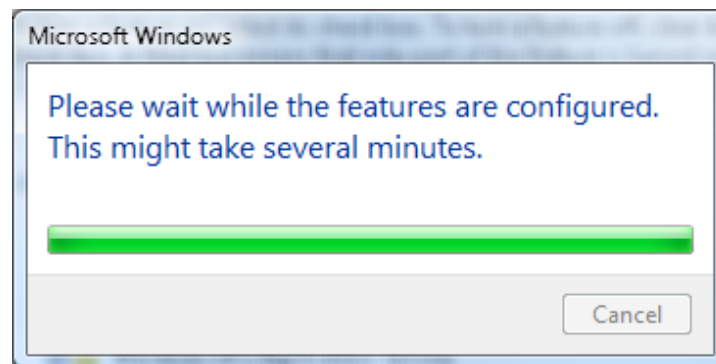

Specsheet for “RS232 by TELNET” :

1. Telnet: TCP
2. Telnet port: 23 (for more detail, kindly please get contact with the service agent or team)
3. Telnet utility: Windows “TELNET.exe” (console mode)
4. Disconnection for RS232-by-Telnet control normally: Close Windows Telnet utility directly after TELNET connection ready
5. Limitation 1 for Telnet-Control: there is only one connection for Telnet-Control in one projector
Limitation 2 for Telnet-Control: there is less than 50 bytes for successive network payload for Telnet-Control application.
Limitation 3 for Telnet-Control: there is less than 26 bytes for one complete RS232 command for Telnet-Control.
Limitation 4 for Telnet-Control: Minimum delay for next RS232 command must be more than 200 (ms).
(* , In Windows built-in “TELNET.exe” utility, “Enter” key pressed will have “Carriage-Return” and “New-Line” code.)

Advanced 2 Feature

Press the **Menu** button to open the **OSD** menu. Press ◀▶ to move to the **Settings 2** menu. Press ▲▼ to move to the **Advanced 2** menu and then press **Enter** or ▶. Press ▲▼ to move up and down in the **Advanced 2** menu. Press ◀▶ to enter and change values for setting.

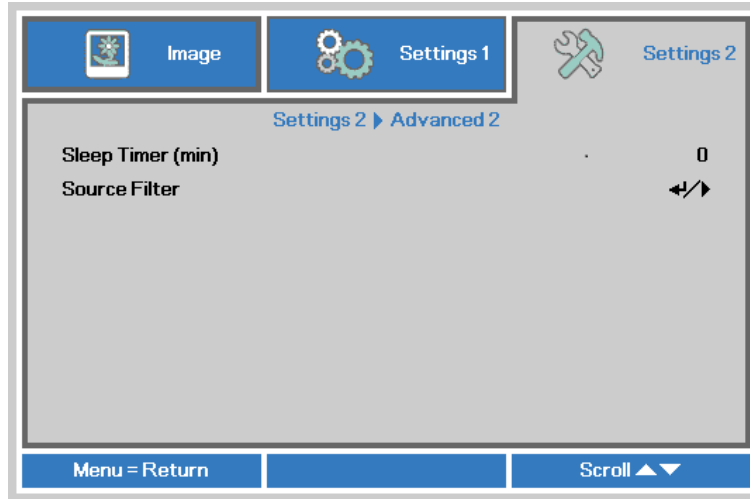

ITEM	DESCRIPTION
Sleep Timer (min)	Press the cursor ◀▶ buttons to enter and set Sleep timer. The projector automatically turns off after the preset period of time.
Source Filter	Press ◀ (Enter) / ▶ to enter the Source Filter menu. See page 45 for more information on Source Filter .

Source Filter

Press the **ENTER** button to enter the **Source Filter** sub menu.

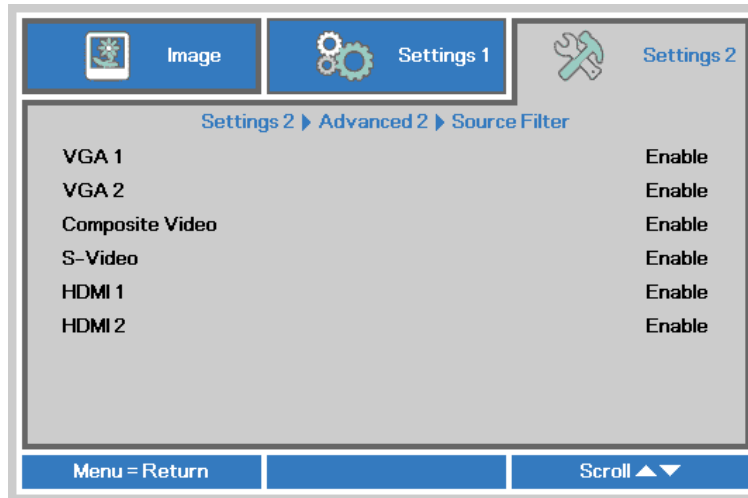

ITEM	DESCRIPTION
VGA1	Press the ◀▶ buttons to enter and enable or disable the VGA1 source.
VGA2	Press the ◀▶ buttons to enter and enable or disable the VGA2 source.
Composite Video	Press the ◀▶ buttons to enter and enable or disable the Composite Video source.
S-Video	Press the ◀▶ buttons to enter and enable or disable the S-Video source.
HDMI1	Press the ◀▶ buttons to enter and enable or disable the HDMI source.
HDMI2	Press the ◀▶ buttons to enter and enable or disable the HDMI source.

MAINTENANCE AND SECURITY

Replacing the Projection Lamp

The projection lamp should be replaced when it burns out. It should only be replaced with a certified replacement part, which you can order from your local dealer.



Important:

- a. The projection lamp used in this product contains a small amount of mercury.*
- b. Do not dispose this product with general household waste.*
- c. Disposal of this product must be carried out in accordance with the regulations of your local authority.*



Warning:

Be sure to turn off and unplug the projector at least 30 minutes before replacing the lamp. Failure to do so could result in a severe burn.



Caution:

In rare cases the lamp bulb may burn out during normal operation and cause glass dust or shards to be discharged outward from the rear exhaust vent.

Do not inhale or do not touch glass dust or shards. Doing so could result in injury.

Always keep your face away from the exhaust vent so that you do not suffer from the gas and broken shards of the lamp.

When removing the lamp from a ceiling-mounted projector, make sure that no one is under the projector. Glass fragments could fall if the lamp has been burned out.



IF A LAMP EXPLODES

If a lamp explodes, the gas and broken shards may scatter inside the projector and they may come out of the exhaust vent. The gas contains toxic mercury.

Open windows and doors for ventilation.

If you inhale the gas or the shards of the broken lamp enter your eyes or mouth, consult the doctor immediately.

- 1.** Remove the single screw on the lamp compartment cover.

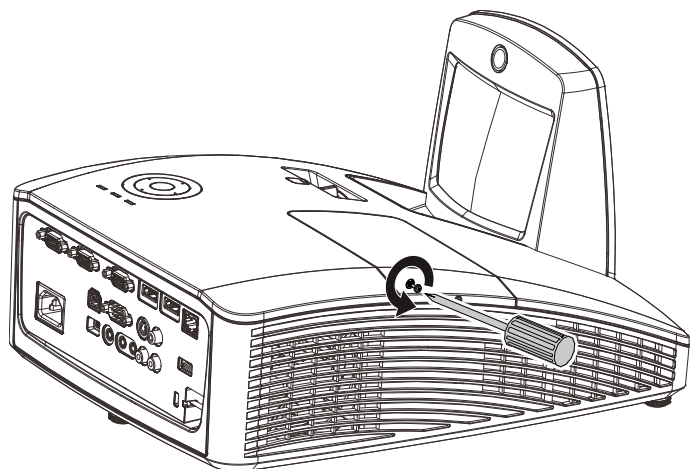

2. Remove the lamp compartment cover.

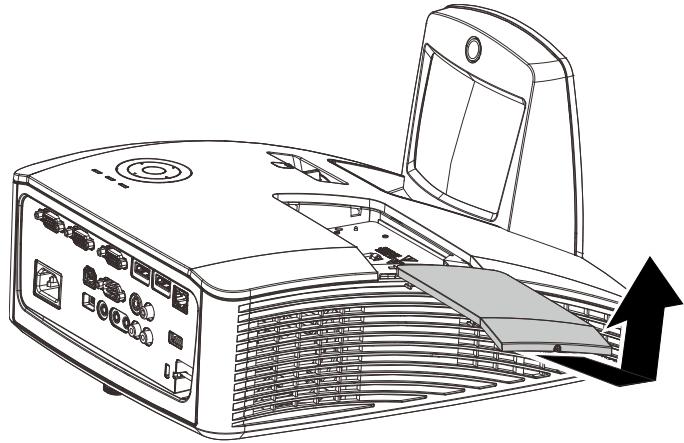

3. Remove the two screws from the lamp module.

4. Lift the module handle up.

5. Pull firmly on the module handle to remove the lamp module.

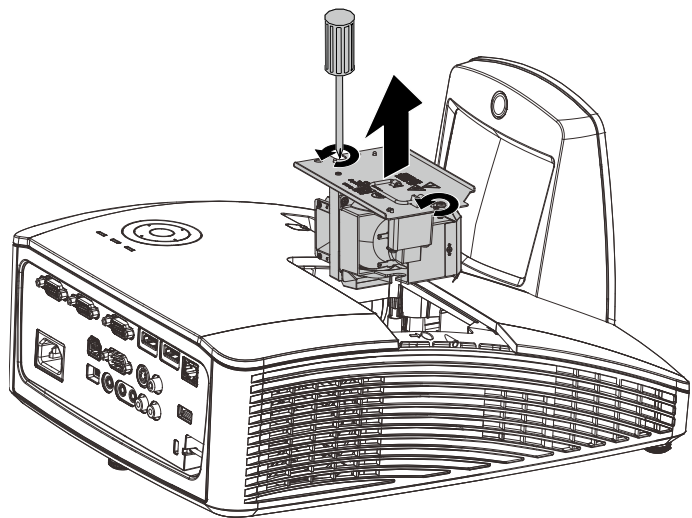

6. Reverse steps 1 to 5 to install the new lamp module. While installing, align the lamp module with the connector and ensure it is level to avoid damage.

Note: The lamp module must sit securely in place and the lamp connector must be connected properly before tightening the screws.

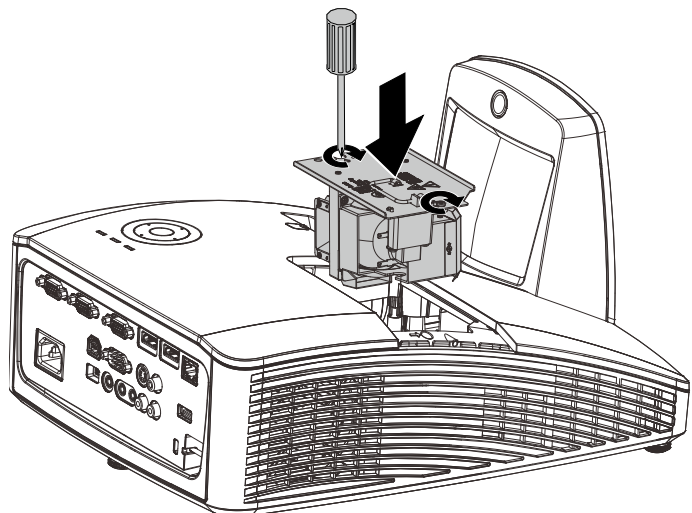

Resetting the Lamp

After replacing the lamp, you should reset the lamp hour counter to zero. Refer to the following:

1. Press the **MENU** button to open the OSD menu.
2. Press the cursor ◀▶ button to move to the **Settings 2** menu. Press the cursor button to move down to **Advanced 1** and press enter.
3. Press the cursor ▼▲ button to move down to **Lamp Hour Reset**.
4. Press the cursor ▶ or Enter button.
A message screen appears.
5. Press ▼▲◀▶ buttons to reset the lamp hour.
6. Press the **MENU** button to get back to **Settings 2**.

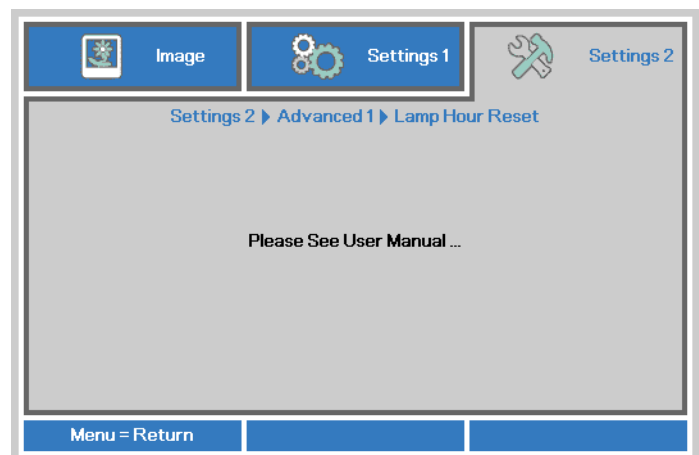
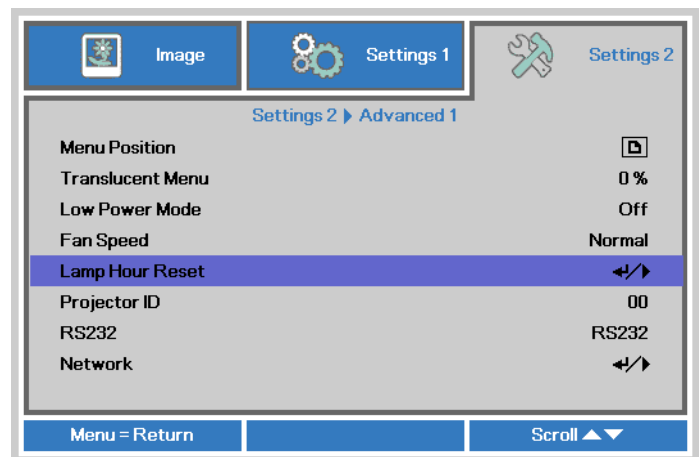
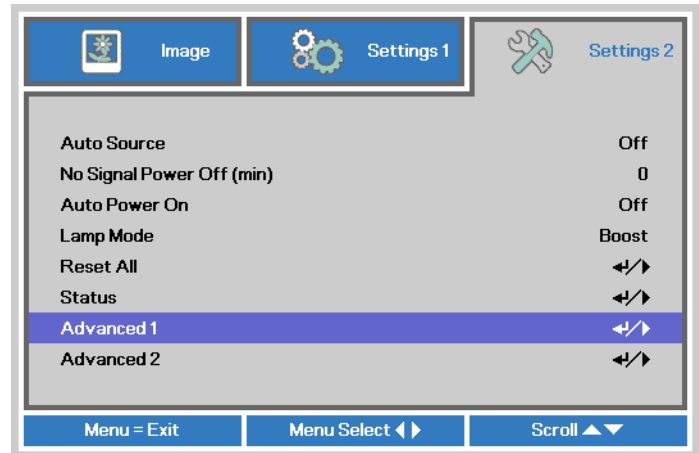

Cleaning the filter (filter: optional parts)

The air filter prevents dust from accumulating on the surface of the optical elements inside the projector. If the filter is dirty or clogged, your projector may overheat or degrading the projected image quality.

- 1.** Turn off the projector, and unplug the AC power cord from the AC outlet.
- 2.** Cleaning the filter with a vacuum cleaner.

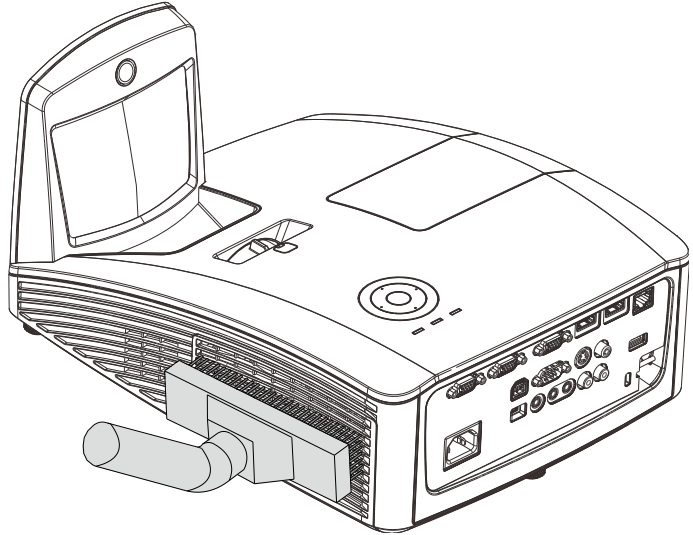

Caution:

Recommend avoiding dusty or smoky environments when you operate the projector, it may cause poor image quality.

If the filter is heavily clogged and unable to clean, replace a new filter.

Note:

Using a ladder is recommended to access the filter. Do not remove the projector from the wall mount.

Replacing the Filter

1. Turn off the projector, and unplug the AC power cord from the AC outlet. Clean up the dust on the projector and around the air vents. Pull out the filter cover and remove from the projector

Use soft brush gently to clean the filter dust both side.

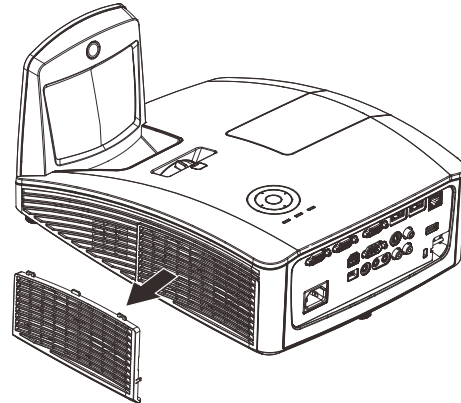

2. Or lift the filter from the filter cover.

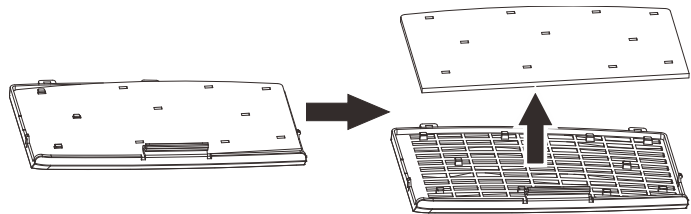

3. Replace a new filter module or replace filter into cover.

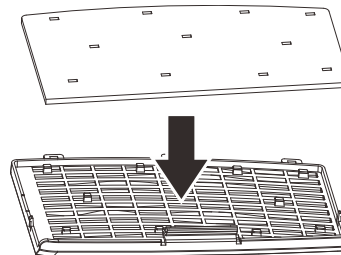

4. Replace the filter cover back to the projector by pushing gently in the direction shown.

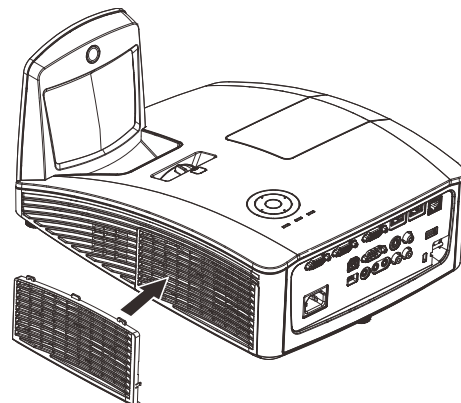
**Warning:**

Do not wash the filter with the water or other liquid matter.

**Important:**

When the lamp is replaced, the filter should also be replaced, not cleaned.

Cleaning the Projector

Cleaning the projector to remove dust and grime will help ensure trouble-free operation.

Cleaning the Projector Mirror:

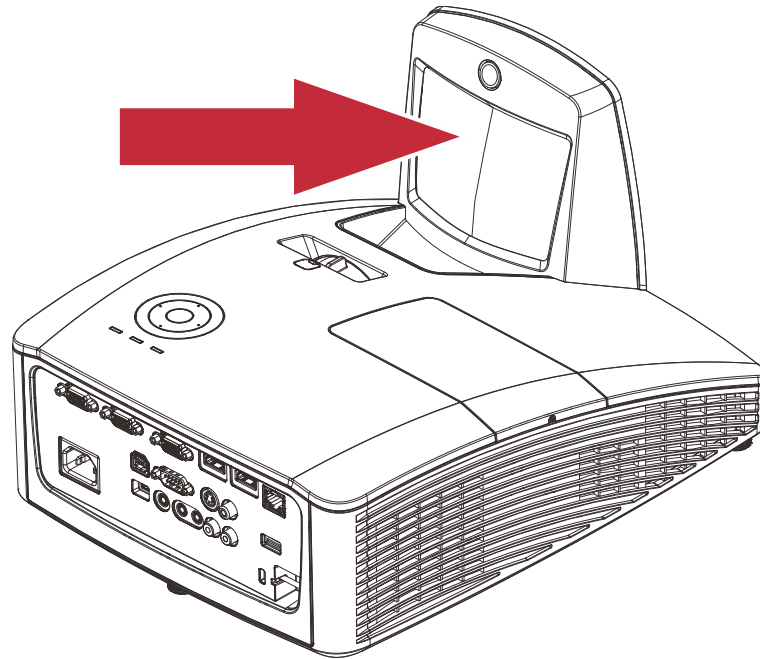

Remove dust with a "Bellows/Lens Blower" readily available from Camera shops to prevent scratching the mirror when subsequently wiped.

 **Cautions:**

1. Always turn the projector off and allow to cool for at least 30 minutes prior to cleaning.
2. Never touch the projector mirror or Lens directly by hand.
3. Do not use abrasive cleaners, solvents or other harsh chemical cleaners.

Cleaning the Case

Refer to the following to clean the projector case.

1. Wipe off dust with a clean dampened cloth.
2. Moisten the cloth with warm water and mild detergent (such as used to wash dishes), and then wipe the case.
3. Rinse all detergent from the cloth and wipe the projector again.



Caution:

To prevent discoloration or fading of the case, do not use abrasive alcohol-based cleaners.



Warning:

1. *Be sure to turn off and unplug the projector at least 30 minutes before cleaning. Failure to do so could result in a severe burn.*
2. *Use only a dampened cloth when cleaning. Do not allow water to enter the ventilation openings on the projector.*
3. *If a little water gets into the projector interior while cleaning, leave unplugged in a well-ventilated room for several hours before using.*
4. *If a lot of water gets into the projector interior when cleaning, have the projector serviced.*

Using the Physical Lock

Using the Kensington Security Slot

If you are concerned about security, attach the projector to a permanent object with the Kensington slot and a security cable.

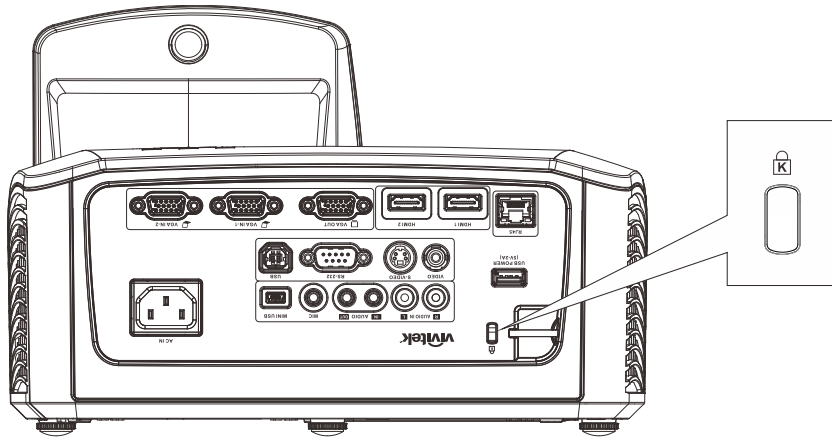

Note:

Contact your vendor for details on purchasing a suitable Kensington security cable.

The security lock corresponds to Kensington's MicroSaver Security System. If you have any comment, contact: Kensington, 2853 Campus Drive, San Mateo, CA 94403, U.S.A. Tel: 800-535-4242, <http://www.Kensington.com>.

Using the Security Bar

In addition to the password protection function and the Kensington lock, the Security Bar helps protect the projector from unauthorized removal.

See the following picture.

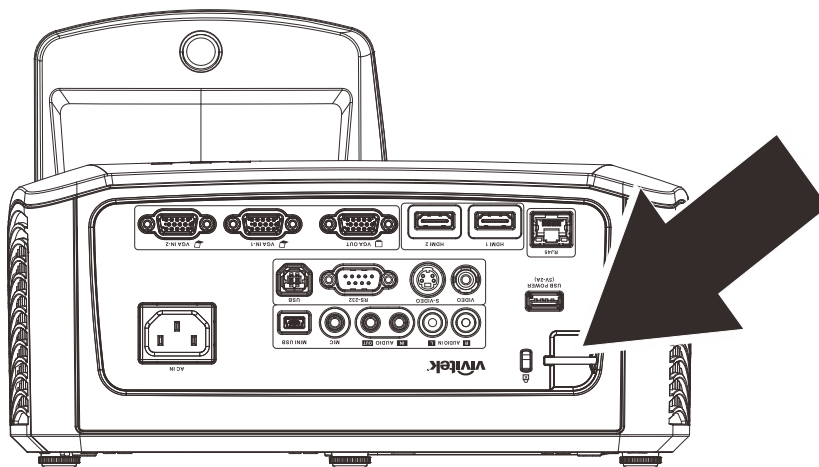

TROUBLESHOOTING

Common problems and solutions

These guidelines provide tips to deal with problems you may encounter while using the projector. If the problem remains unsolved, contact your dealer for assistance.

Often after time spent troubleshooting, the problem is traced to something as simple as a loose connection. Check the following before proceeding to the problem-specific solutions.

- *Use some other electrical device to confirm that the electrical outlet is working.*
- *Ensure the projector is turned on.*
- *Ensure all connections are securely attached.*
- *Ensure the attached device is turned on.*
- *Ensure a connected PC is not in suspending mode.*
- *Ensure a connected notebook computer is configured for an external display. (This is usually done by pressing a Fn-key combination on the notebook).*

Tips for Troubleshooting

In each problem-specific section, try the steps in the order suggested. This may help you to solve the problem more quickly.

Try to pin point the problem and thus avoid replacing non-defective parts.

For example, if you replace batteries and the problem remains, put the original batteries back and go to the next step.

Keep a record of the steps you take when troubleshooting: The information may be useful when calling for technical support or for passing on to service personnel.

LED Error Messages

ERROR CODE MESSAGES	POWER LED GREEN	LAMP LED RED	TEMP LED RED
System Initial	Flashing	OFF	OFF
Ready to Power on (Standby)	ON	OFF	OFF
System Power on	Flashing	OFF	OFF
Lamp Lit , System stable	ON	OFF	OFF
Cooling	Flashing	OFF	OFF
Over Temperature	OFF	OFF	ON
Thermal Break Sensor error	4 blinks	OFF	OFF
Lamp Fail	5 blinks	ON	OFF
Lamp Temperature shut down	5 blinks	1 blinks	OFF
Lamp Short circuit in output detected	5 blinks	2 blinks	OFF
Lamp End of lamp life detected	5 blinks	3 blinks	OFF
Lamp did not ignite	5 blinks	4 blinks	OFF
Lamp extinguished during normal operation	5 blinks	5 blinks	OFF
Lamp extinguished during run-up phase	5 blinks	6 blinks	OFF
Lamp voltage got error	5 blinks	7 blinks	OFF
Lamp ballast got error	5 blinks	8 blinks	OFF
Ballast watt value is out of range (Lamp Normal & Eco mode)	5 blinks	9 blinks	OFF
Lamp ballast Communication error	5 blinks	10 blinks	OFF
Fan-1 error	6 blinks	1 blinks	OFF
Fan-2 error	6 blinks	2 blinks	OFF
Fan-3 error	6 blinks	3 blinks	OFF
Fan-4 error	6 blinks	4 blinks	OFF
Case Open	7 blinks	OFF	OFF
DAD1000 error	8 blinks	OFF	OFF
Color wheel error	9 blinks	OFF	OFF

In the event of an error, please disconnect the AC power cord and wait for one (1) minute before restarting the projector. If the Power or Lamp LEDs are still blinking or any other situation that isn't listed in the chart above, please contact your service center.

Image Problems

Problem: No image appears on the screen

1. Verify the settings on your notebook or desktop PC.
2. Turn off all equipment and power up again in the correct order.

Problem: The image is blurred

1. Adjust the **Focus** on the projector.
2. Press the **Auto** button on the remote control.
3. Ensure the projector-to-screen distance is within the specified range.
4. Check that the projector lens is clean.

Problem: The image is wider at the top or bottom (trapezoid effect)

1. Position the projector so it is as perpendicular to the screen as possible.
2. Use the **Keystone** button on the remote control to correct the problem.

Problem: The image is reversed

Check the **Projection** setting on the **Settings 1** menu of the OSD.

Problem: The image is streaked

1. Set the **Frequency** and **Tracking** settings on the **Image->Computer** menu of the OSD to the default settings.
2. To ensure the problem is not caused by a connected PC's video card, connect to another computer.

Problem: The image is flat with no contrast

Adjust the **Contrast** setting on the **Image** menu of the OSD.

Problem: The color of the projected image does not match the source image.

Adjust the **Color Temperature** and **Gamma** settings on the **Image->Advanced** menu of the OSD.

Lamp Problems

Problem: There is no light from the projector

1. Check that the power cable is securely connected.
2. Ensure the power source is good by testing with another electrical device.
3. Restart the projector in the correct order and check that the Power LED is on.
4. If you have replaced the lamp recently, try resetting the lamp connections.
5. Replace the lamp module.
6. Put the old lamp back in the projector and have the projector serviced.

Problem: The lamp goes off

1. Power surges can cause the lamp to turn off. Re-plug power cord. When the Power LED is on, press the power button.
2. Replace the lamp module.
3. Put the old lamp back in the projector and have the projector serviced.

Remote Control Problems

Problem: The projector does not respond to the remote control

1. Direct the remote control towards remote sensor on the projector.
2. Ensure the path between remote and sensor is not obstructed.
3. Turn off any fluorescent lights in the room.
4. Check the battery polarity.
5. Replace the battery.
6. Turn off other Infrared-enabled devices in the vicinity.
7. Have the remote control serviced.

Audio Problems

Problem: There is no sound

1. Adjust the volume on the remote control.
2. Adjust the volume of the audio source.
3. Check the audio cable connection.

4. Test the source audio output with other speakers.
5. Have the projector serviced.

Problem: The sound is distorted

1. Check the audio cable connection.
2. Test the source audio output with other speakers.
3. Have the projector serviced.

Having the Projector Serviced

If you are unable to solve the problem, you should have the projector serviced. Pack the projector in the original carton. Include a description of the problem and a checklist of the steps you took when trying to fix the problem: The information may be useful to service personnel. For servicing, return the projector to the place you purchased it.

HDMI Q & A

Q. What is the difference between a “Standard” HDMI cable and a “High-Speed” HDMI cable?

1. Recently, HDMI Licensing, LLC announced that cables would be tested as Standard or High-Speed cables.
2. Standard (or “category 1”) HDMI cables have been tested to perform at speeds of 75Mhz or up to 2.25Gbps, which is the equivalent of a 720p/1080i signal.
3. High Speed (or “category 2”) HDMI cables have been tested to perform at speeds of 340Mhz or up to 10.2Gbps, which is the highest bandwidth currently available over an HDMI cable and can successfully handle 1080p signals including those at increased color depths and/or increased refresh rates from the Source. High-Speed cables are also able to accommodate higher resolution displays, such as WQXGA cinema monitors (resolution of 2560 x 1600).

Q. How do I run HDMI cables longer than 10 meters?

4. There are many HDMI Adopters working on HDMI solutions that extend a cable's effective distance from the typical 10 meter range to much longer lengths. These companies manufacture a variety of solutions that include active cables (active electronics built into cables that boost and extend the cable's signal), repeaters, amplifiers as well as CAT5/6 and fiber solutions.

Q. How can I tell if a cable is an HDMI certified cable?

5. All HDMI products are required to be certified by the manufacturer as part of the HDMI Compliance Test Specification. However, there may be instances where cables bearing the HDMI logo are available but have not been properly tested. HDMI Licensing, LLC actively investigates these instances to ensure that the HDMI trademark is properly used in the market. We recommend that consumers buy their cables from a reputable source and a company that is trusted.

For more detail information check <http://www.hdmi.org/learningcenter/faq.aspx#49>

SPECIFICATIONS

Specifications

Model	D756USTi	D757WT
Display type	DMD 0.65" WXGA	
Resolution	WXGA 1280 x 800 Native	
Projection distance	605mm - 755mm	
Projection screen size	16:10 (80"~100")	
Projection lens	Fix	
Throw ratio	0.35 : 1	
Vertical keystone correction	+/- 40 degrees	
Projection methods	Front, Rear, Desktop/Ceiling (Rear, Front)	
Data compatibility	VGA, SVGA, XGA, SXGA, UXGA, Mac	
SDTV/EDTV/ HDTV	480i, 576i, 480p, 576p, 720p, 1080i, 1080p	
Video compatibility	NTSC/NTSC 4.43, PAL (B/G/H/I/M/N/60), SECAM	
H-Sync	15, 30 – 91.4 kHz	
V-Sync	24-30, 47-120 Hz	
Safety certification	FCC, UL, cUL, CB, CE, CCC, KC, PSB, GOST, CECP, NOM, ICES-003, C-TICK	
Operation temperature	0° ~ 40°C	
Dimensions	287.5 mm (W) x 186 mm (H) x 374.5 mm (D)	287.5 mm (W) x 167.58 mm (H) x 374.5 mm (D)
AC Input	AC Universal 100 ~ 240V	
Power consumption	320W , <0.5W (Stand By)	
Lamp	230W	
limited lens shift function	Yes	—
Audio speaker	10W x2 (stereo)	
Interactive function	Yes	
Input Terminals	VGA x 2	
	Mini jack x 1 (Audio In)	
	Composite Video x 1	
	HDMI x 2	
	S-Video x 1	
	Audio In (L/R) x 1	
	MIC x 1	
Output Terminals	VGA x 1 (Loop Thru only for VGA IN-1)	
	Mini jack x 1 (Audio out)	
Control Terminals	RS-232C	
	RJ45	
	USB (type B)	
	Mini USB (Interactive used)	—
Security	USB (type A) 5V2A	
	Kensington Security Slot	

Projection Distance vs. Projection Size

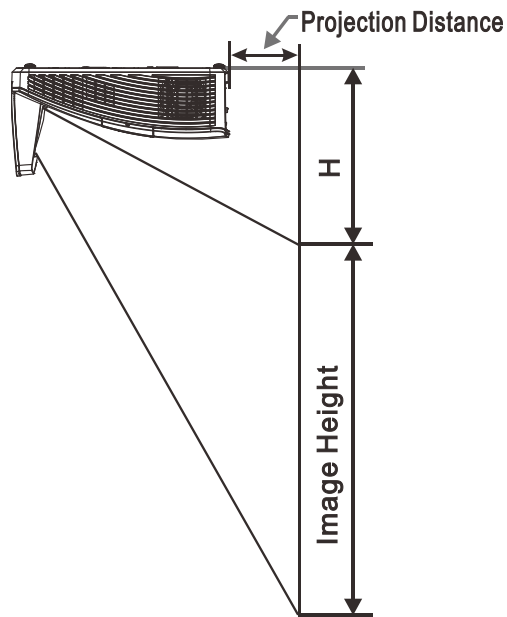

Projection Distance and Size Table

	D756USTi / D757WT			
	WXGA			
	16:10			
Diagonal	80"	87"	97"	100"
Distance	282.3+/-20mm	340.3+/-20mm	421.4+/-20mm	445.8+/-20mm
Image Width	1723mm	1874mm	2088mm	2154mm
Image height	1077mm	1171mm	1305mm	1346mm
H	280+/-50mm	300.2+/-50mm	325.5+/-50mm	336.9+/-50mm

Timing Mode Table

The projector can display several resolutions. The following table outlines the resolutions that can be displayed by the projector.

SIGNAL	RESOLUTION	H-SYNC (KHz)	V-SYNC (Hz)	COMPOSITE S_VIDEO	COMPONENT	RGB (ANALOG)	DP/HDMI (DIGITAL)
NTSC	—	15.7	60.0	○	—	—	—
PAL/SECAM	—	15.6	50.0	○	—	—	—
VESA	640 x 400	37.9	85.1	—	—	○	○
	720 x 400	31.5	70.1	—	—	○	○
	720 x 400	37.9	85.0	—	—	○	○
	640 x 480	31.5	60.0	—	—	○	○
	640 x 480	37.9	72.8	—	—	○	○
	640 x 480	37.5	75.0	—	—	○	○
	640 x 480	43.3	85.0	—	—	○	○
	800 x 600	35.2	56.3	—	—	○	○
	* 800 x 600	37.9	60.3	—	—	○	○
	800 x 600	46.9	75.0	—	—	○	○
	800 x 600	48.1	72.2	—	—	○	○
	800 x 600	53.7	85.1	—	—	○	○
	** 800 x 600	76.3	120.0	—	—	○	○
	1024 x 576	35.8	60.0	—	—	○	○
	1024 x 600	37.3	60.0	—	—	○	○
	1024 x 600	41.5	65.0	—	—	○	○
	* 1024 x 768	48.4	60.0	—	—	○	○
	1024 x 768	56.5	70.1	—	—	○	○
	1024 x 768	60.0	75.0	—	—	○	○
	1024 x 768	68.7	85.0	—	—	○	○
	** 1024 x 768	97.6	120.0	—	—	○	○
	1024 x 768	99.0	120.0	—	—	○	○
	1152 x 864	67.5	75.0	—	—	○	○
	* 1280 x 720	45.0	60.0	—	—	○	○
	* 1280 x 720	90.0	120.0	—	—	○	○
	1280 x 768	47.4	60.0	—	—	○	○
	* 1280 x 768	47.8	59.9	—	—	○	○
	* 1280 x 800	49.7	59.8	—	—	○	○
	1280 x 800	62.8	74.9	—	—	○	○
	1280 x 800	71.6	84.9	—	—	○	○
	** 1280 x 800	101.6	119.9	—	—	○	○
	*** 1280 x 1024	64.0	60.0	—	—	○	○
	1280 x 1024	80.0	75.0	—	—	○	○
	1280 x 1024	91.1	85.0	—	—	○	○
	*** 1280 x 960	60.0	60.0	—	—	○	○
	1280 x 960	85.9	85.0	—	—	○	○
*** 1360 x 768	47.7	60.0	—	—	○	○	
*** 1400 x 1050	65.3	60.0	—	—	○	○	
1440 x 900	55.5	59.9	—	—	○	○	
*** 1440 x 900	55.9	59.9	—	—	○	○	
1440 x 900	70.6	75.0	—	—	○	○	

SIGNAL	RESOLUTION	H-SYNC (KHz)	V-SYNC (Hz)	COMPOSITE S_VIDEO	COMPONENT	RGB (ANALOG)	DP/HDMI (DIGITAL)
	1600 x1200	75.0	60.0	—	—	○	○
	1680 x 1050	64.7	59.9	—	—	○	○
	1680 x 1050	65.3	60.0	—	—	○	○
	1920 x 1200	74.0	60.0	—	—	○	○
	1920 x 1080	67.5	60.0	—	—	○	○
Apple Macintosh	640 x 480	35.0	66.7	—	—	○	○
	832 x 624	49.7	74.5	—	—	○	○
	1024 x 768	60.2	74.9	—	—	○	○
	1152 x 870	68.7	75.1	—	—	○	○
SDTV	480i	15.7	60.0	—	○	—	○
	576i	15.6	50.0	—	○	—	○
EDTV	576p	31.3	50.0	—	○	—	○
	480p	31.5	60.0	—	○	—	○
HDTV	720p	37.5	50.0	—	○	—	○
	720p	45.0	60.0	—	○	—	○
	1080i	33.8	60.0	—	○	—	○
	1080i	28.1	50.0	—	○	—	○
	1080p	27.0	24.0	—	○	—	○
	1080p	28.0	25.0	—	○	—	○
	1080p	33.7	30.0	—	○	—	○
	1080p	56.3	50.0	—	○	—	○
	1080p	67.5	60.0	—	○	—	○

O: Frequency supported

—: Frequency not supported

★3D note :

“★” It means the timing can support non-3D and 3D signal with Frame Sequential and Top-Bottom format.

“★★”It means the timing can support non-3D and 3D signal with Frame Sequential format.

“★★★”It means the timing can support non-3D and 3D signal with Top-Bottom format.

There 3D timing showing depend the EDID file and display card. It is possible that user cannot choose the above 3D timings on display card.

★The resolution of the panel is 1280 x 800. Resolution other than native resolution may display with uneven size of text or lines.

★The color of mean Displayable only. (4:3 only)

★The color of mean may have a little noise is acceptable, Because video mode sync don't auto adjustment.

★HDTV timing main check tool is DVD player, VG828 is secondary

Projector Dimensions (D756USTi)

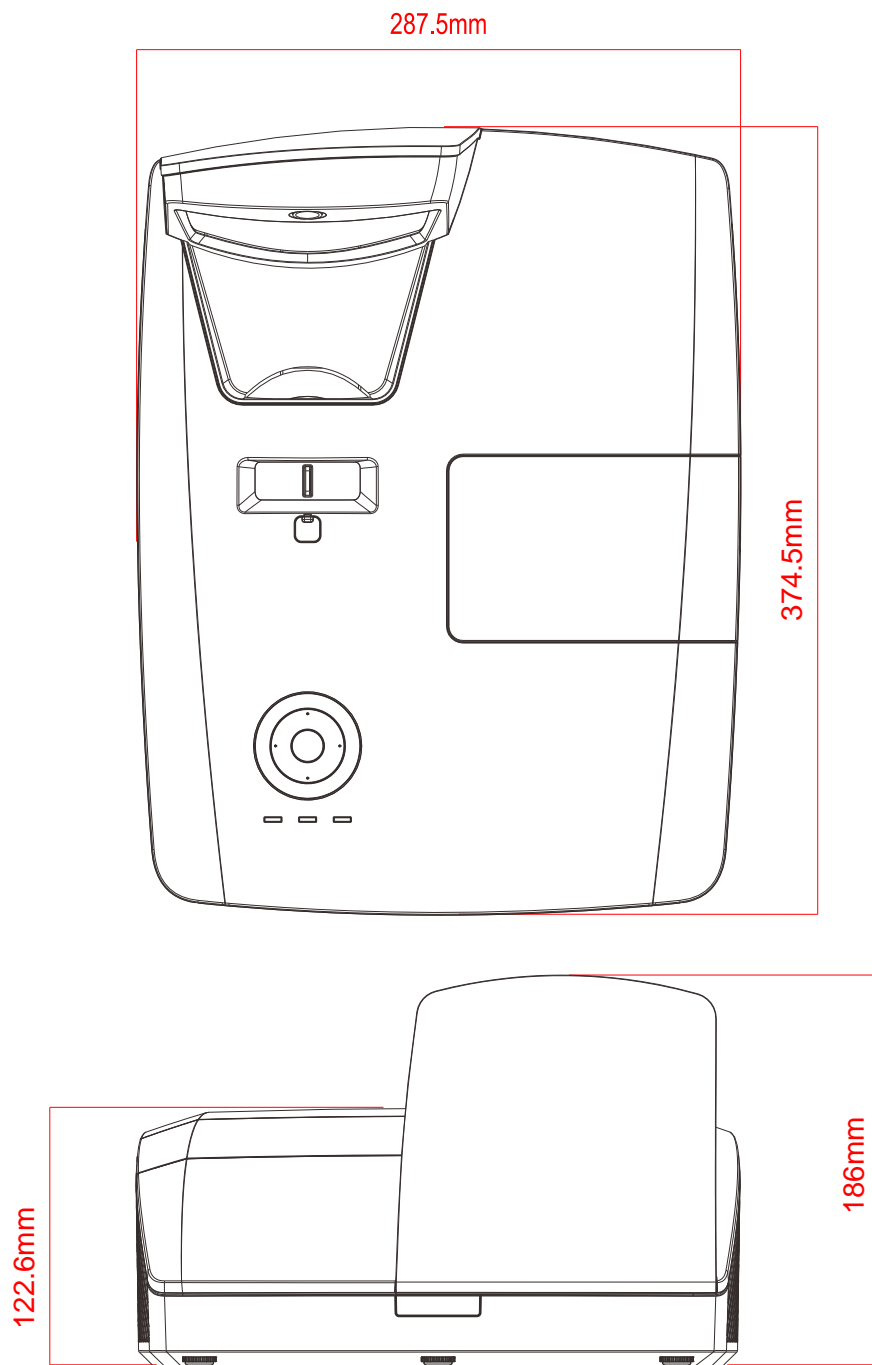

Projector Dimensions (D757WT)

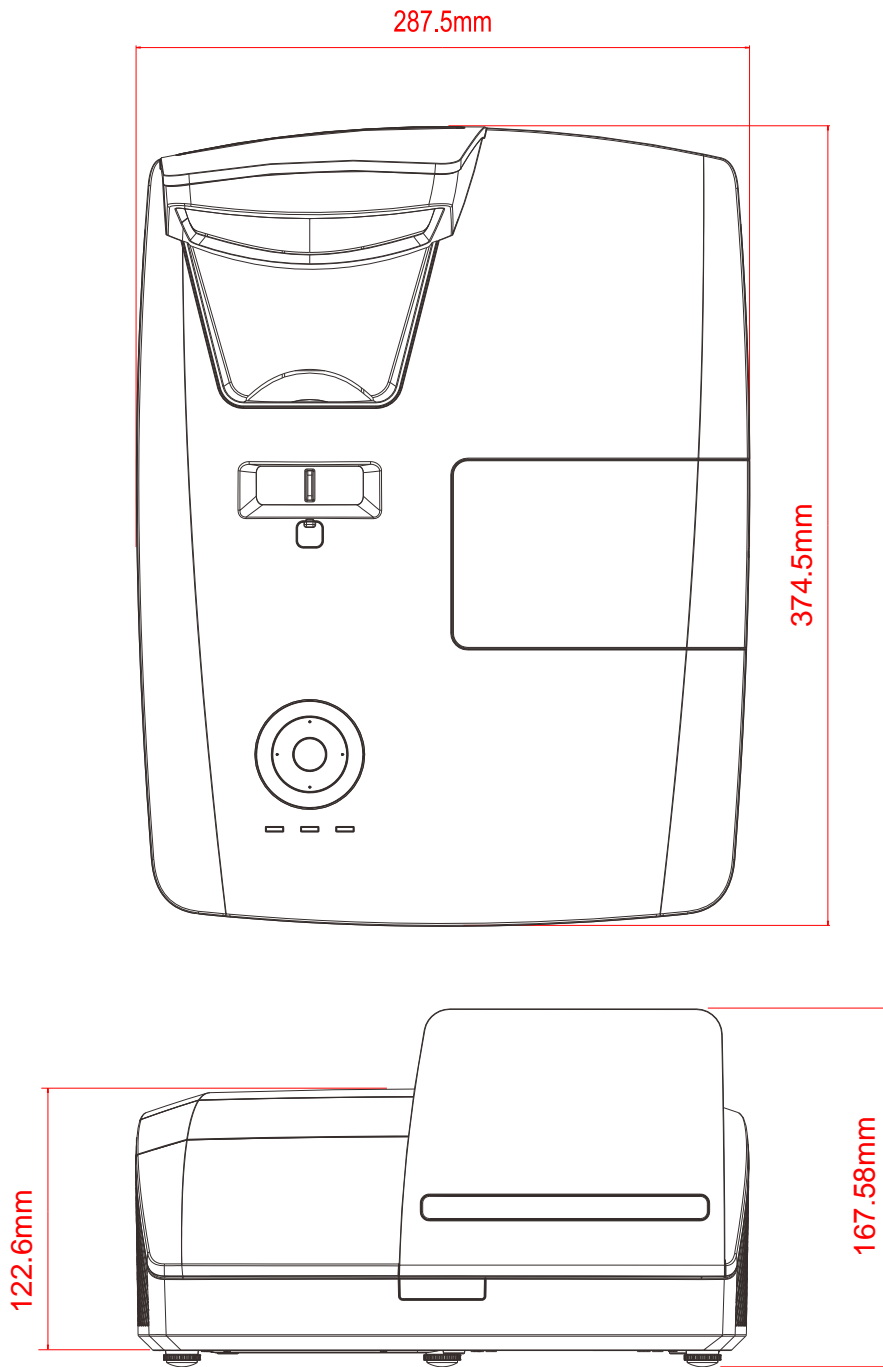

REGULATORY COMPLIANCE

FCC Warning

This equipment has been tested and found to comply with the limits for a Class B digital device pursuant to Part 15 of the FCC Rules. These limits are designed to provide reasonable protection against harmful interference when the equipment is operated in a commercial environment.

This equipment generates, uses, and can radiate radio frequency energy and, if not installed and used in accordance with the instruction manual, may cause harmful interference to radio communications. Operation of this equipment in a residential area is likely to cause harmful interference in which case the user will be required to correct the interference at his/her own expense.

Changes or modifications not expressly approved by the parties responsible for compliance could void the user's authority to operate the equipment.

Canada

This class B digital apparatus complies with Canadian ICES-003.

Safety Certifications

FCC, UL, cUL, CB, CE, CCC, KC, PSB, GOST, CECP, NOM, ICES-003, C-TICK

APPENDIX I

RS-232C Protocol

RS232 Setting

Baud rate:	9600
Parity check:	None
Data bit:	8
Stop bit:	1
Flow Control	None

Control Command Structure

	Header code	Command code	Data code	End code
HEX		Command	Data	0Dh
ASCII	'V'	Command	Data	CR

Operation Command

<p>Note:</p> <p>"CR" mean Carriage Return</p> <p>XX=00-98, projector's ID, XX=99 is for all projectors</p> <p>Return Result P=Pass / F=Fail</p> <p>n: 0:Disable/1: Enable/Value(0~9999)</p>

Command Group 00

ASCII	HEX	Function	Description	Return Result
VXXS0001	56H 39H 39H 53H 30H 30H 30H 31H 0DH	Power On		P/F
VXXS0002	56H 39H 39H 53H 30H 30H 30H 32H 0DH	Power Off		P/F
VXXS0003	56H 39H 39H 53H 30H 30H 30H 33H 0DH	Resync		P/F
VXXG0004	56H 39H 39H 47H 30H 30H 30H 34H 0DH	Get Lamp Hours		Pn/F
VXXS0006	56H 39H 39H 53H 30H 30H 30H 36H 0DH	System Reset		P/F
VXXG0007	56H 39H 39H 47H 30H 30H 30H 37H 0DH	Get System Status	0:Reset 1:Standby 2:Operation 3:Cooling	Pn/F
VXXG0008	56H 39H 39H 47H 30H 30H 30H 38H 0DH	Get F/W Version		Pn/F

Command Group 01

ASCII	HEX	Function	Description	Return Value
VXXG0101	56H 39H 39H 47H 30H 31H 30H 31H 0DH	Get Brightness	n=0~100	Pn/F
VXXS0101n	56H 39H 39H 53H 30H 31H 30H 31H n 0DH	Set Brightness	n=0~100	P/F
VXXG0102	56H 39H 39H 47H 30H 31H 30H 32H 0DH	Get Contrast	n=0~100	Pn/F
VXXS0102n	56H 39H 39H 53H 30H 31H 30H 32H n 0DH	Set Contrast	n=0~100	P/F
VXXG0103	56H 39H 39H 47H 30H 31H 30H 33H 0DH	Get Color	n=0~100	Pn/F
VXXS0103n	56H 39H 39H 53H 30H 31H 30H 33H n 0DH	Set Color	n=0~100	P/F
VXXG0104	56H 39H 39H 47H 30H 31H 30H 34H 0DH	Get Tint	n=0~100	Pn/F
VXXS0104n	56H 39H 39H 53H 30H 31H 30H 34H n 0DH	Set Tint	n=0~100	P/F
VXXG0105	56H 39H 39H 47H 30H 31H 30H 35H 0DH	Get Sharpness	0~31	Pn/F

Command Group 01				
ASCII	HEX	Function	Description	Return Value
VXXS0105n	56H 39H 39H 53H 30H 31H 30H 35H n 0DH	Set Sharpness	0~31	P/F
VXXG0106	56H 39H 39H 47H 30H 31H 30H 36H 0DH	Get Color Temperature	0:Warm 1:Normal 2:Cold	Pn/F
VXXS0106n	56H 39H 39H 53H 30H 31H 30H 36H n 0DH	Set Color Temperature	0:Warm 1:Normal 2:Cold	P/F
VXXG0107	56H 39H 39H 47H 30H 31H 30H 37H 0DH	Get Gamma	0:1.8 1:2.0 2:2.2 3:2.4 4: B&W 5:Linear	Pn/F
VXXS0107n	56H 39H 39H 53H 30H 31H 30H 37H n 0DH	Set Gamma	0:1.8 1:2.0 2:2.2 3:2.4 4: B&W 5:Linear	P/F

Command Group 02				
ASCII	HEX	Function	Description	Return Value
VXXS0201	56H 39H 39H 53H 30H 32H 30H 31H 0DH	Select RGB		P/F
VXXS0202	56H 39H 39H 53H 30H 32H 30H 32H 0DH	Select RGB2		P/F
VXXS0204	56H 39H 39H 53H 30H 32H 30H 34H 0DH	Select Video		P/F
VXXS0205	56H 39H 39H 53H 30H 32H 30H 35H 0DH	Select S-Video		P/F
VXXS0206	56H 39H 39H 53H 30H 32H 30H 36H 0DH	Select HDMI		P/F
VXXS0210	56H 39H 39H 53H 30H 32H 31H 30H 0DH	Select DisplayPort		P/F
VXXG0220	56H 39H 39H 47H 30H 32H 32H 30H 0DH	Get Current Source	Return 1:RGB 2:RGB2 4:Video 5:S-Video 6:HDMI 10:DisplayPort	Pn/F

Command Group 03				
ASCII	HEX	Function	Description	Return Value
VXXG0301	56H 39H 39H 47H 30H 33H 30H 31H 0DH	Get Scaling	0: Fill 1: 4:3 2: 16:9 3 :Letter Box 4 :Native 5: 2.35:1	Pn/F
VXXS0301n	56H 39H 39H 53H 30H 33H 30H 31H n 0DH	Set Scaling	0: Fill 1: 4:3 2: 16:9 3 :Letter Box 4 :Native 5: 2.35:1	P/F
VXXG0302	56H 39H 39H 47H 30H 33H 30H 32H 0DH	Blank		Pn/F

Command Group 03				
ASCII	HEX	Function	Description	Return Value
VXXS0302n	56H 39H 39H 53H 30H 33H 30H 32H n 0DH	Blank		P/F
VXXG0303	56H 39H 39H 47H 30H 33H 30H 33H 0DH	Auto Keystone On		Pn/F
VXXS0303n	56H 39H 39H 53H 30H 33H 30H 33H n 0DH	Auto Keystone On		P/F
VXXG0304	56H 39H 39H 47H 30H 33H 30H 34H 0DH	Freeze On		Pn/F
VXXS0304n	56H 39H 39H 53H 30H 33H 30H 34H n 0DH	Freeze On		P/F
VXXG0305	56H 39H 39H 47H 30H 33H 30H 35H 0DH	Volume	n=0~8	Pn/F
VXXS0305n	56H 39H 39H 53H 30H 33H 30H 35H n 0DH	Volume	n=0~8	P/F
VXXG0308	56H 39H 39H 47H 30H 33H 30H 38H 0DH	Projection Mode	0:Front 1:Rear 2:Ceiling 3:Rear+Ceiling	Pn/F
VXXS0308n	56H 39H 39H 53H 30H 33H 30H 38H n 0DH	Projection Mode	0:Front 1:Rear 2:Ceiling 3:Rear+Ceiling	P/F
VXXG0309	56H 39H 39H 47H 30H 33H 30H 39H 0DH	Set vertical keystone value	n= -40~40	Pn/F
VXXS0309n	56H 39H 39H 53H 30H 33H 30H 39H n 0DH	Set vertical keystone value	n= -40~40	P/F
VXXG0311	56H 39H 39H 47H 30H 33H 31H 31H 0DH	Adjust the zoom	n= -10~10	Pn/F
VXXS0311n	56H 39H 39H 53H 30H 33H 31H 31H n 0DH	Adjust the zoom	n= -10~10	P/F

Command Group 04 (Remote Control)				
ASCII	HEX	Function	Description	Return Value
VXXS0401	56H 39H 39H 53H 30H 34H 30H 31H 0DH	UP arrow		P/F
VXXS0402	56H 39H 39H 53H 30H 34H 30H 32H 0DH	DOWN arrow		P/F
VXXS0403	56H 39H 39H 53H 30H 34H 30H 33H 0DH	LEFT arrow		P/F
VXXS0404	56H 39H 39H 53H 30H 34H 30H 34H 0DH	RIGHT arrow		P/F
VXXS0405	56H 39H 39H 53H 30H 34H 30H 35H 0DH	POWER		P/F
VXXS0406	56H 39H 39H 53H 30H 34H 30H 36H 0DH	EXIT		P/F
VXXS0407	56H 39H 39H 53H 30H 34H 30H 37H 0DH	INPUT		P/F
VXXS0408	56H 39H 39H 53H 30H 34H 30H 38H 0DH	AUTO		P/F
VXXS0409	56H 39H 39H 53H 30H 34H 30H 39H 0DH	KEYSTONE+		P/F
VXXS0410	56H 39H 39H 53H 30H 34H 31H 30H 0DH	KEYSTONE-		P/F
VXXS0411	56H 39H 39H 53H 30H 34H 31H 31H 0DH	MENU		P/F
VXXS0412	56H 39H 39H 53H 30H 34H 31H 32H 0DH	STATUS		P/F
VXXS0413	56H 39H 39H 53H 30H 34H 31H 33H 0DH	MUTE		P/F
VXXS0414	56H 39H 39H 53H 30H 34H 31H 34H 0DH	ZOOM+		P/F
VXXS0415	56H 39H 39H 53H 30H 34H 31H 35H 0DH	ZOOM-		P/F
VXXS0416	56H 39H 39H 53H 30H 34H 31H 36H 0DH	BLANK		P/F
VXXS0417	56H 39H 39H 53H 30H 34H 31H 37H 0DH	FREEZE		P/F
VXXS0418	56H 39H 39H 53H 30H 34H 31H 38H 0DH	VOLUME+		P/F
VXXS0419	56H 39H 39H 53H 30H 34H 31H 39H 0DH	VOLUME-		P/F
VXXS0420	56H 39H 39H 53H 30H 34H 32H 30H 0DH	Enter		P/F